

Dell™ PowerConnect™ 5224 Systems User's Guide

[Caution: Safety Instructions](#)

[Introduction](#)

[Installation](#)

[Management Interface](#)

[VLANs](#)

[Appendix](#)

Notes, Notices, and Cautions



NOTE: A NOTE indicates important information that helps you make better use of your computer.



NOTICE: A NOTICE indicates either potential damage to hardware or loss of data and tells you how to avoid the problem.



CAUTION: A CAUTION indicates a potential for property damage, personal injury, or death.

Information in this document is subject to change without notice.
© 2002 Dell Computer Corporation. All rights reserved.

Reproduction in any manner whatsoever without the written permission of Dell Computer Corporation is strictly forbidden.

Trademarks used in this text: *Dell*, the *DELL* logo, *PowerConnect*, *Dimension*, *Inspiron*, *Dell Precision*, *OptiPlex*, *Latitude*, and *DellNet* are trademarks of Dell Computer Corporation; *Microsoft* and *Windows* are registered trademarks of Microsoft Corporation.

Other trademarks and trade names may be used in this document to refer to either the entities claiming the marks and names or their products. Dell Computer Corporation disclaims any proprietary interest in trademarks and trade names other than its own.

August 2002 P/N 5P788 Rev. A01

Introduction

Dell™ PowerConnect™ 5224 Systems User's Guide

- [Features](#)
 - [Front-Panel Components](#)
 - [Back-Panel Descriptions](#)
 - [Management](#)
-

Features

The Dell™ PowerConnect™ 5224 Gigabit Ethernet Managed Switch offers the following features:

- 1 24 10/100/1000BASE-T auto-sensing Gigabit Ethernet switching ports
- 1 Four 10/100/1000BASE-T ports operate in combination with four Small Form Factor Pluggable (SFP) transceiver slots
- 1 IEEE 802.3u, IEEE 802.3z, and IEEE 802.3ab compliant
- 1 Up to 32 kilobyte (KB)-entry, media access control (MAC) address cache
- 1 IEEE 802.3x flow control for full duplex operation
- 1 IEEE 802.1Q based tagged virtual local area network (VLAN)
- 1 IEEE 802.1p Class of Service (CoS) through four priority queues for each port
- 1 IEEE 802.3ad link aggregation: up to six aggregated trunks per switch
- 1 Support for jumbo frames up to 9 KB
- 1 Spanning tree protocol
- 1 Broadcast storm control
- 1 Internet group management protocol (IGMP) snooping support
- 1 Back pressure flow control for half-duplex operation
- 1 Port mirroring
- 1 Auto MDI/MDIX support for the 10/100/1000BASE-T ports
- 1 MAC addresses lookup based on port, VLAN ID, and MAC addresses
- 1 Redundant power supply (RPS) support for uninterrupted operation
- 1 System light-emitting diode (LED) and per port LEDs
- 1 Standard 1U chassis
- 1 19-inch rack-mountable

Management Features

- 1 Web-based management with embedded HTTP server
- 1 Text-based management through four in-band Telnet sessions, and an out-of-band RS-232 console port (VT100)
- 1 Simple network management protocol (SNMP)-based network management through an SNMP management console program
- 1 RADIUS access control
- 1 Software upload through Trivial File Transfer Protocol (TFTP)
- 1 Dual firmware image support
- 1 Supports Boot Protocol (BOOTP) and Dynamic Host Configuration Protocol (DHCP) for IP address assignment
- 1 Hardware-assisted remote monitoring (RMON) statistic collection
- 1 Management information base (MIB) II (RFC 1213)
- 1 Interfaces Evolution MIB (RFC 2863)
- 1 Ethernet-like MIB (RFC 2665)
- 1 Bridge MIB (RFC 1493)
- 1 Extended Bridge MIB (RFC 2674)
- 1 RMON MIB (RFC 2819)
- 1 Entity MIB (RFC 2737)
- 1 RADIUS authentication client MIB (RFC 2618)
- 1 Dell PowerConnect 5224 Private MIB

Front-Panel Components

The front panel of the switch contains the console port, all of the Ethernet ports, and LEDs. As shown in the following figure, the switch has three system LEDs and one LED for each port. The following sections describe the front panel in more detail.



PWR LED

The PWR (power) LED shows the general operating status of the system. Indicator states include:

- 1 Off — The unit is off with no power connections.
- 1 Green — The unit's internal power supply is operating normally.
- 1 Red — The unit's internal power supply has failed.

RPS LED

The RPS LED shows the operating status of a connected redundant power unit. Indicator states include:

- 1 Off — The RPS is not connected.
- 1 Green — The RPS is operating normally.
- 1 Red — The RPS has failed.

DIAG LED

The diagnostic (DIAG) LED shows the status of the system diagnostics during initialization. Indicator states include:

- 1 Blinking green — The system diagnostic test is in progress.
- 1 Green — The system diagnostic test has completed successfully.
- 1 Red — The system diagnostic test has detected a fault.

Console Port

You can access the console interface from the RS-232 serial port or a Telnet connection. The console port uses a standard null-modem cable. For instructions on configuring your switch using the console, see "[Management Interface](#)."

Port LEDs

Two of the LEDs show the operating status of each Gigabit Ethernet port, and the other LED shows the operating status of each SFP transceiver slot. Details of the LED indications are provided in each of the following sections.

Gigabit Ethernet Ports

Link Status and Activity (LINK/ACT)

- 1 Green — A 1000-megabits per second (Mbps) link is up and there is no activity.
- 1 Blinking green — A 1000-Mbps link is up and there is activity.
- 1 Orange — A 10/100-Mbps link is up and there is no activity.
- 1 Blinking orange — A 10/100-Mbps link is up and there is activity.
- 1 Flashing orange — The link is in the admin down state.
- 1 Off — The link is down.

Duplex Mode (FDX)

- 1 Green — A full-duplex link is up.
- 1 Off — A half-duplex link is up.

SFP Transceiver Ports

SFP Transceiver Status

- 1 Green — An SFP transceiver is correctly installed in the slot.
 - 1 Off — An SFP transceiver is not installed in the slot.
-

Back-Panel Descriptions

The back panel of the system contains the AC power receptacle and the RPS connector.



AC Power Receptacle

The switch automatically adjusts its power setting to any supply voltage in the range of 90 to 240 V alternating current (VAC).

RPS Connector

Connect the optional RPS to the RPS connector. If the switch's internal power unit fails, the redundant power system automatically supplies power to the switch for uninterrupted operation.

The switch supports the Dell PowerConnect RPS-600 external redundant power system.

 **NOTE:** See the RPS-600 documentation for more information.

 **CAUTION:** Do not use this switch with any redundant power system other than the Dell PowerConnect RPS-600.

Management

The following sections describe options for managing the switch.

Web-Based Interface

 **NOTE:** To access the switch through a web browser, the computer running the web browser must have IP-based network access to the switch.

After you have successfully installed the switch, you can configure the switch, monitor the LED panel, and display statistics graphically using a web browser, such as Netscape Navigator (version 6.2 and higher) or Microsoft® Internet Explorer (version 5.0).

Command-Line-Driven Console Interface Through a Serial Port or Telnet

You can also connect a computer or terminal to the serial console port or use Telnet to access the switch. The command-line-driven interface provides complete access to all switch management features. Most of the common commands are described in "[Management Interface](#)." For a full list of commands, see the *Command Line Reference*, which is included on the documentation CD.

SNMP-Based Management

You can manage the switch with an SNMP-compatible console program. The switch is compatible with SNMP version 1.0.

The SNMP agent decodes the incoming SNMP messages and responds to requests with MIB objects stored in the database. The SNMP agent updates the MIB objects every 5 seconds to generate statistics and counters.

The switch supports a comprehensive set of MIB extensions:

- 1 RFC 1213 MIB II
 - 1 RFC 2863 Interfaces Evolution MIB
 - 1 RFC 2665 Ethernet-Like MIB
 - 1 RFC 1493 Bridge MIB
 - 1 RFC 2674 Extended Bridge MIB
 - 1 RFC 2819 RMON MIB
 - 1 RFC 2737 Entity MIB
 - 1 RFC 2618 RADIUS authentication client MIB
 - 1 Dell PowerConnect 5224 Private MIB
-

[Back to Contents Page](#)

[Back to Contents Page](#)

Installation

Dell™ PowerConnect™ 5224 Systems User's Guide

- [Package Contents](#)
 - [Before You Connect to the Network: Mounting Kit Instructions](#)
 - [External Redundant Power System](#)
 - [Connecting the Console Port](#)
 - [Password Protection](#)
 - [SNMP Settings](#)
 - [IP Address Assignment](#)
 - [Connecting Devices to the Switch](#)
-

Package Contents

Before you begin installing the switch, confirm that your package contains the following items:

- 1 Switch
 - 1 AC power cable
 - 1 Null modem cable
 - 1 Self-adhesive rubber pads for desktop installation
 - 1 Rack mount kit for rack installation
 - 1 Documentation CD
-

Before You Connect to the Network: Mounting Kit Instructions

 **NOTICE:** Do not connect the switch to the network until you have established the correct Internet Protocol (IP) settings.

Before you connect to the network, you must install the switch on a flat surface or in a rack, set up a terminal emulation program, plug in the power cord, and then set up a password and IP address.

The switch is supplied with rubber feet for stationing it on a flat surface and mounting brackets and screws for mounting the switch in a rack.

Installing the Switch Without the Rack

Install the switch on a level surface that can safely support the weight of the switch and its attached cables. The switch must have adequate space for ventilation and for accessing cable connectors.

1. Set the switch on a flat surface and check for proper ventilation.

Allow at least 2 inches (5.1 centimeters [cm]) on each side of the switch and 5 inches (12.7 cm) at the back for the power cable.

2. Attach the rubber feet on the marked locations on the bottom of the chassis.

The rubber feet, although optional, are recommended to keep the unit from slipping.

Installing the Switch in a Rack

You can install the switch in most standard 19-inch (48.3-cm) racks.

 **NOTE:** For racks that are not prethreaded, cage nuts are provided.

1. Use the supplied screws to attach a mounting bracket to each side of the switch.
 2. Align the holes in the mounting bracket with the holes in the rack.
 3. Insert and tighten two screws through each of the mounting brackets.
-

External Redundant Power System

The switch supports the Dell PowerConnect RPS-600 external redundant power system.

 **NOTE:** See the RPS-600 documentation for more information.

 **CAUTION:** Do not use the switch with any redundant power system other than the Dell PowerConnect RPS-600.

Connecting the Console Port

The switch provides an RS-232 serial port that enables a connection to a computer or terminal for monitoring and configuring the switch. This port is a male DB-9 connector, implemented as a data terminal equipment (DTE) connection.

To use the console port, you need the following equipment:

- 1 A terminal or a computer with both a serial port and the ability to emulate a terminal
- 1 A null modem or crossover RS-232 cable with a female DB-9 connector for the console port on the switch

To connect a terminal to the console port:

1. Connect the female connector of the RS-232 cable directly to the console port on the switch, and tighten the captive retaining screws.
2. Connect the other end of the cable to a terminal or to the serial connector of a computer running terminal emulation software.

Set the terminal emulation software as follows:

- a. Select the appropriate serial port (COM port 1 or COM port 2).
- b. Set the data rate to 9600 baud.
- c. Set the data format to 8 data bits, 1 stop bit, and no parity.
- d. Set flow control to `none`.
- e. Under **Properties**, select **VT100 for Emulation** mode.
- f. Select **Terminal keys** for **Function**, **Arrow**, and **Ctrl keys**. Ensure that you select **Terminal keys** (*not Windows keys*).

➔ **NOTICE:** When you use HyperTerminal with the Microsoft® Windows® 2000 operating system, ensure that you have Windows 2000 Service Pack 2 or later installed. Windows 2000 Service Pack 2 allows you to use arrow keys in HyperTerminal's VT100 emulation. See www.microsoft.com for information on Windows 2000 service packs.

3. After you have correctly set up the terminal, plug the power cable into the power receptacle on the back of the switch. The boot sequence appears in the terminal.
4. After the boot sequence completes, the console login screen displays. If you have not logged into the command line interface (CLI) program, the default user names are `admin` and `guest`, and the corresponding passwords are `admin` and `guest`.
 - 1 If you log in as `guest`, the CLI displays the `console>` prompt to indicate that you are using the CLI in normal access (Normal Exec) mode.
 - 1 If you log in as `admin`, the CLI displays the `console#` prompt to indicate that you are using the CLI in privileged access (Privileged Exec) mode.
5. Enter the commands to complete your desired tasks. Many commands require Privileged Exec-level access.

CLI commands for most common tasks are provided in "[Management Interface](#)." See the *Command Line Reference* on the documentation CD for a list of all commands and additional information on using the CLI.

6. When you have completed your tasks, exit the session with the **Quit** command.

Password Protection

To proceed through the CLI initial login screen, you must enter a password. If you have not logged into the CLI program, the default user names are `admin` and `guest`, and the corresponding passwords are `admin` and `guest`. If you log in as `guest`, you have access to the Normal Exec level. If you log in as `admin`, you have access to the Privileged Exec level.

```
User Access Verification

Username: admin

Password:

CLI session with the PowerConnect 5224 is opened.

To end the CLI session, enter [Exit].

Console#
```

After your initial login, define new passwords for both default user names to prevent unauthorized access to the switch, and record the passwords for future reference.

1. At the CLI login prompt, enter `admin` as the user name and password for the Privileged Exec level. Press <Enter>.
2. Type `configure` and press <Enter>.

 **NOTE:** Passwords are case sensitive.

3. To set the Normal Exec level password, type `username guest password 0 password`, where `password` is your new password (up to eight characters). Press <Enter>.
4. To set the Privileged Exec level password, type `username admin password 0 password`, where `password` is your new password (up to eight characters). Press <Enter>.
5. To save your configuration changes, type `copy running-config startup-config` and then press <Enter>.

 **NOTICE:** CLI configuration commands only modify the running configuration file and are not saved when the switch is rebooted. To save all your configuration changes in nonvolatile storage, you must use the **copy** command to copy the running configuration file to the startup configuration.

SNMP Settings

Simple Network Management Protocol (SNMP) is a protocol designed specifically for managing devices on a network. Network equipment, such as hubs, switches, and routers, use SNMP to configure system features for proper operation, as well as to monitor their performance and detect potential problems.

Managed devices that support SNMP include software (referred to as an agent), which runs locally on the device. A defined set of variables (managed objects) is maintained by the SNMP agent and used to manage the device. These objects are defined in a Management Information Base (MIB), which provides a standard presentation of the information controlled by the agent. SNMP defines both the format of the MIB specifications and the protocol used to access this information over the network.

The PowerConnect 5224 switch includes an on-board SNMP agent that monitors the status of the switch hardware, as well as the traffic passing through the ports. A computer on the network running SNMP-based management software, called a Network Management Station (NMS), can be used to access this information. Access rights to the SNMP agent are controlled by community strings. To communicate with the switch, the NMS must first submit a valid community string for authentication.

The default community strings for the switch are:

- 1 public — Allows authorized management stations to retrieve MIB objects.
- 1 private — Allows authorized management stations to retrieve and modify MIB objects.

If you do not intend to utilize SNMP, delete both of the default community strings. SNMP management access to the switch is disabled if no community strings exist. To delete the strings:

1. If you are not already in the Privileged Exec level global configuration mode, type `configure` and press <Enter>.
2. To delete the **private** community string, type `no snmp-server community private` and then press <Enter>.
3. To delete the **public** community string, type `no snmp-server community public` and then press <Enter>.
4. To save your configuration changes, type `copy running-config startup-config` and then press <Enter>.

If you do intend to utilize SNMP, change the default community strings to prevent unauthorized access to the switch:

1. If you are not already in the Privileged Exec level global configuration mode, type `configure` and press <Enter>.
 2. To delete the existing **private** community string, type `no snmp-server community private` and then press <Enter>.
 3. Type `snmp-server community string rw`, where *string* is your new community string (case sensitive) for read-write access. Press <Enter>.
 4. To delete the existing **public** community string, type `no snmp-server community public` and then press <Enter>.
 5. Type `snmp-server community string ro`, where *string* is your new community string (case sensitive) for read-only access. Press <Enter>.
 6. To save your configuration changes, type `copy running-config startup-config` and then press <Enter>.
-

IP Address Assignment

You must assign an IP address to the switch to gain management access over the network. You may also need to establish a default gateway between the switch and management stations that exist on another network segment. You can statically configure a specific IP address or direct the switch to obtain an address from a Boot Protocol (BOOTP) or Dynamic Host Configuration Protocol (DHCP) server when it is powered on. Valid IP addresses consist of four decimal numbers, 0 to 255, separated by periods. Anything outside this format is not accepted by the CLI program.

 **NOTICE:** By default, the IP address is assigned to VLAN 1 through DHCP.

If you select the **bootp** or **dhcp** option, IP is enabled but does not function until a BOOTP or DHCP reply has been received. Requests are broadcast periodically by the switch in an effort to learn its IP address. (BOOTP and DHCP values can include the IP address, default gateway, and subnet mask).

To display assigned IP settings using the CLI:

1. From the Privileged Exec or Normal Exec level mode, type `show ip interface` and press <Enter>.

The assigned IP address and subnet mask displays.

2. From the Privileged Exec mode, type `show ip redirects` to display the assigned gateway IP address. Press <Enter>.

The following example displays IP settings assigned by **bootp** or **dhcp** using the CLI.

```
Console#show ip interface
IP address and netmask: 10.1.0.1 255.255.252.0 on VLAN 1,
and address mode: User specified.
Console# show ip redirects
ip default gateway 10.1.0.254
Console#
```

Before you can assign a static IP address to the switch, you must obtain the following information from your network administrator:

- 1 IP address for the switch
- 1 Default gateway for the network
- 1 Network mask for the network

To assign a static IP address to the switch:

1. From the Privileged Exec level global configuration mode prompt, type `interface vlan 1` to access the interface-configuration mode. Press <Enter>.
2. Type `ip address ip-address netmask`, where `ip-address` is the switch IP address and `netmask` is the network mask for the network.
3. Type `exit` to return to the global configuration mode prompt. Press <Enter>.
4. To set the IP address of the default gateway for the network to which the switch belongs, type `ip default-gateway gateway`, where `gateway` is the IP address of the default gateway. Press <Enter>.
5. To save your configuration changes, type `copy running-config startup-config` and then press <Enter>.

 **NOTICE:** Only one VLAN can be assigned an IP address. If you assign an address to any other VLAN, the new address overrides the original IP address.

The following example shows how to set a static IP address using the CLI.

```
Console(config)# interface vlan 1

Console(config-if)# ip address 192.168.1.5 255.255.255.0

Console(config-if)# exit

Console(config)# ip default-gateway 192.168.1.254

Console(config)#
```

To configure the switch for DHCP or BOOTP:

1. From the Privileged Exec level global configuration mode prompt, type `interface vlan 1` to access the interface-configuration mode. Press <Enter>.
2. At the next prompt, use one of the following commands:
 - 1 To obtain IP settings through DHCP, type `ip address dhcp`
 - 1 To obtain IP setting through BOOTP, type `ip address bootp`
3. Press <Enter>.
4. To save your configuration changes, type `copy running-config startup-config`, and then press <Enter>.

Connecting Devices to the Switch

After you assign IP addresses to the switch, you can connect devices to the RJ-45 connectors on the switch.

 **NOTICE:** If autonegotiation is disabled for an RJ-45 port, the auto-MDI/MDI-X pin signal configuration is also disabled.

To connect a device to an SFP transceiver port:

1. Use your cabling requirements to select an appropriate SFP transceiver type.
2. Insert the SFP transceiver (sold separately) into the SFP transceiver slot. The slot's LED indicator turns on to confirm that it is correctly installed.
3. Use the appropriate network cabling to connect a device to the connectors on the SFP transceiver.

 **NOTICE:** When the SFP transceiver acquires a link, the associated integrated 10/100/1000BASE-T port is disabled.

[Back to Contents Page](#)

[Back to Contents Page](#)

Management Interface

Dell™ PowerConnect™ 5224 Systems User's Guide

- [Web Pages](#)
- [System](#)
- [Switch](#)
- [Ports](#)
- [Address Table](#)
- [Spanning Tree](#)
- [VLAN](#)
- [Class of Service](#)
- [Link Aggregation](#)
- [SNMP](#)
- [Multicast Support](#)
- [Statistics](#)

With web-based management, you can configure the PowerConnect 5224 Gigabit Ethernet Managed Switch and monitor the system using a web browser.

Most pages for the switch include the following buttons:

- 1 **Refresh** — Displays the current values for the system related to the page that is open.
- 1 **Apply Changes** — Makes changes to the system and refreshes the page.

➔ **NOTE:** For configuration changes to persist beyond the current session, you must either save the **running-config** file from the Switch/Configuration page or use the command line interface (CLI) command **copy running-config startup-config**.

Web Pages

When you connect to the management mode of the switch with a web browser, a login screen is displayed. Enter a user name and password to access the switch's management mode.

🔒 **NOTE:** The default user names are *admin* and *guest*, and the corresponding passwords are *admin* and *guest*. If you log in as *guest* (Normal Exec level), you can only view page information and change the guest password. If you log in as *admin* (Privileged Exec level), you can apply changes on all pages.

The following menus are available from the web interface:

- 1 **Switch**
- 1 **Ports**
- 1 **Address Table**
- 1 **Spanning Tree**
- 1 **VLAN**
- 1 **Class of Service**
- 1 **Link Aggregation**
- 1 **SNMP**
- 1 **Multicast Support**
- 1 **Statistics**

System

The **System** page contains a dynamic switch applet that displays the current status of the switch ports. The color of each switch port icon indicates its link status:

- 1 Green — The link is up.
- 1 Grey — The link is down.

Clicking on any port icon displays the port configuration page.



Switch

The **Switch** page contains all system operations and general information. It includes links to the following options:

- 1 **General** — Allows you to view general system information and perform general administration.
- 1 **IP Address** — Allows you to view or edit Internet Protocol (IP) parameters.
- 1 **Security** — Allows you to set the password for your login username.
- 1 **Firmware** — Allows you to transfer a firmware upgrade to the switch.
- 1 **Configuration** — Allows you to save or restore switch configuration files.
- 1 **Reset** — Allows you to reboot the switch.

General Information

The **General** page contains links to the following pages:

- 1 **Asset**
- 1 **Health**
- 1 **Versions**
- 1 **Logs**

Asset

The **Asset** page contains the following information:

- 1 **MAC Address**
- 1 **SNMP Object ID**
- 1 **System Up Time**

It also includes the following editable fields:

- 1 **System Name**
- 1 **System Contact**
- 1 **System Location**

To save any changes you make in this page, click **Apply Changes**. If you don't want to save the changes, click **Refresh**.

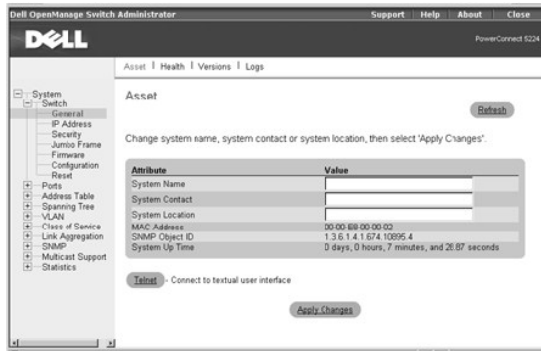

CLI Commands

The following table summarizes the equivalent CLI commands for items in the **Switch/General/Asset** page.

Command	Usage
show system	Displays system information
hostname <i>name</i>	Specifies or modifies the system name for this device
snmp-server contact <i>string</i>	Sets the system contact (sysContact) string
snmp-server location <i>text</i>	Sets the system location string

Example

```

Console(config)#hostname Server Chassis 35

Console(config)#snmp-server contact Paul

Console(config)#snmp-server location WC-19

Console(config)#exit

Console#show system

System description: PowerConnect 5224

System OID string: 1.3.6.1.4.1.674.10895.4

System information

  System Up time: 0 days, 0 hours, 14 minutes, and 17.93 seconds

  System Name      : Server Chassis 35

  System Location  : WC-19

  System Contact   : Paul

  MAC address      : 00-00-e8-00-00-02

  Web server       : enable

  Web server port  : 80

  POST result      :

--- Performing Power-On Self Tests (POST) ---

UART Loopback Test ..... PASS

Timer Test ..... PASS

CACHE Test..... PASS

DRAM Test ..... PASS

I2C Initialization ..... PASS

Runtime Image Check ..... PASS

PCI Device Check ..... PASS

Switch Driver Initialization ..... PASS

```

----- DONE -----

Console#

Health

The **Health** page contains the following information:

- 1 **Internal Power Status**
- 1 **Redundant Power Status**

The power status is indicated by the following icons:

- 1 **Green check** — Power is connected and operating.
- 1 **Red cross** — Power is connected but has failed.
- 1 **Not present** — Power is not connected.

To reset these fields to their current value, click **Refresh**.

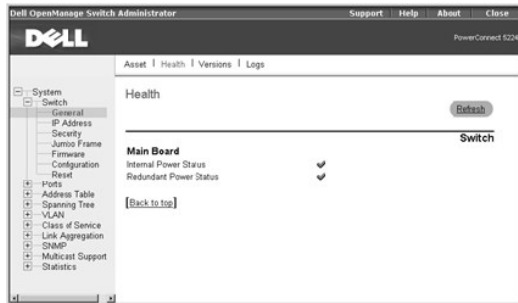

CLI Commands

The following table summarizes the equivalent CLI command for items in the **Switch/General/Health** page.

Command	Usage
show version	Displays hardware and software version information for the system, as well as the unit's power status

Example

```
Console#show version

Unit1

  Serial number      :123457

  Service tag       :3

  Hardware version   :/2002

  Number of ports    :24

  Master power status :up

  Backup power status :up

Agent(master)

  Unit id           :1

  Loader version    :0.0.5.5

  Boot rom version   :0.0.6.0

  Operation code version :0.2.0.0

Console#
```

Versions

The **Versions** page contains the following fields:

- 1 Hardware Version
- 1 Microcode Version
- 1 Loader Version
- 1 Boot-ROM Version
- 1 Operation Code Version
- 1 Total Port Number
- 1 Role
- 1 Service Tag
- 1 Serial Number

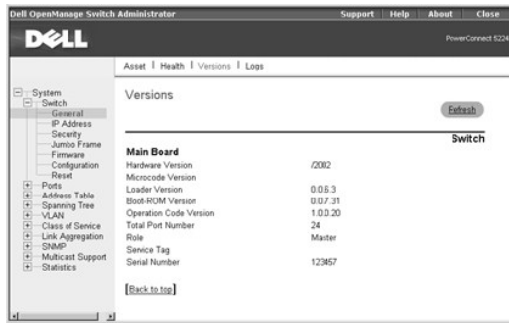

CLI Commands

The following table summarizes the equivalent CLI command for items in the **Switch/General/Versions** page.

Command	Usage
show version	Displays hardware and software version information for the system, as well as the unit's power status

Example

```

Console#show version

Unit1

Serial number      :123457

Service tag       :3

Hardware version   :/2002

Number of ports    :24

Master power status :up

Backup power status :up

Agent(master)

Unit id           :1

Loader version    :0.0.5.5

Boot rom version  :0.0.6.0

Operation code version :0.2.0.0

Console#

```

Logs

The **Logs** page allows you to scroll through the logged system and event messages. The switch can store up to 2 kilobytes (KB) of log entries in temporary random access memory (RAM) (memory flushed on power reset) and up to 4 KB of entries in permanent flash memory.

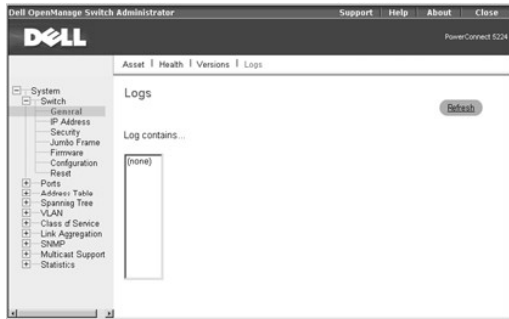

CLI Commands

The following table summarizes the equivalent CLI commands for items in the **Switch/General/Logs** page.

Command	Usage
show logging { flash ram }	Displays the logging configuration for system and event messages
	flash — event history stored in flash memory (permanent memory)
	ram — event history stored in temporary RAM (memory flushed on power reset)

 **NOTE:** The CLI allows you to configure and limit system messages that are logged to flash or RAM memory. The **show logging** command only displays the current logging configuration.

The system log messages are categorized by severity into eight levels, from 0 (Emergencies) to 7 (Debugging). The CLI command **logging history** allows you to specify which messages are logged to RAM or flash memory. The default is for messages with severity levels of 0 to 3 to be logged to flash and levels 0 to 7 to be logged to RAM.

Severe error messages that are logged to flash memory are permanently stored in the switch to assist in troubleshooting network problems. Up to 4 KB of message entries can be stored in the flash memory, with older messages being overwritten first when this memory capacity has been exceeded.

Example

```

Console#show logging flash

Syslog logging: Disable

History logging in FLASH: level errors

Console#

```

IP Address

The **IP Address** page contains links to the following pages:

- 1 [IP Address](#)
- 1 [DHCP](#)

IP Address

From the **IP Address** page, you can manage the IP-related information about the system. The page includes the following editable fields:

- 1 **Management VLAN** — Sets the virtual local area network (VLAN) interface that allows management access to the switch. You can set the IP address for only one VLAN interface.
- 1 **IP Address Mode** — Sets whether IP functionality is enabled through manual (Static) configuration or set by Dynamic Host Configuration Protocol (DHCP) or Boot Protocol (BOOTP).
- 1 **IP Address** — Identifies the IP address of the VLAN interface that allows management access to the switch.
- 1 **Subnet Mask** — Identifies the subnet mask that determines the host address bits used for routing to specific subnets.
- 1 **Gateway IP Address** — Identifies the IP address of the gateway router between the switch and management stations that exist on other network segments.

 **NOTICE:** When DHCP or BOOTP has been used to set the IP information, the **IP Address**, **Subnet Mask**, and **Gateway IP Address** fields display the assigned values.

The Management VLAN is the only VLAN through which you can gain management access to the switch. By default, all ports on the switch are members of VLAN 1, so a management station can be connected to any port on the switch. If other VLANs are configured and you change the Management VLAN, you may lose management access to the switch. In this case, you should reconnect the management station to a port that is a member of the Management VLAN. For more information on the Management VLAN, see "[Management VLAN Access](#)."

To save any changes you make in this page, click **Apply Changes**. If you don't want to save the changes, click **Refresh**.

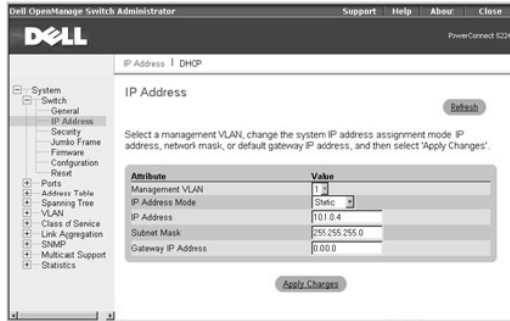

CLI Commands

The following table summarizes the equivalent CLI commands for items in the **Switch/IP Address** page.

Command	Usage
<code>ip address {ip-address netmask bootp dhcp}</code>	Sets the primary IP address for this device. Use the no form command to remove the IP address, or to disable IP address assignment through BOOTP or DHCP.
<code>ip default-gateway gateway</code>	Establishes a static route between the switch and management stations that exist on another network segment.
<code>show ip interface</code>	Displays the usability status of an IP interface.
<code>show ip redirects</code>	Shows the default gateway configured for this device.

Example

```

Console(config)#interface vlan 1

Console(config-if)#ip address 192.168.1.5 255.255.255.0

Console(config-if)#exit

Console(config)#ip default-gateway 192.168.1.254

Console(config)#

```

DHCP

In the **DHCP** page, click **Restart DHCP** to release the current IP address and obtain a new one through DHCP.

- 🔔 **NOTICE:** If **Restart DHCP** is selected when IP settings have been configured statically, a warning message indicating that the IP Address Mode is not set to DHCP displays.

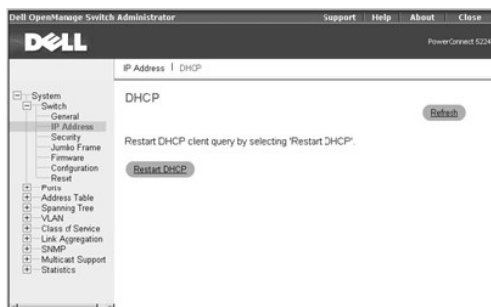

CLI Commands

The following table summarizes the equivalent CLI command for items in the **Switch/IP Address/DHCP** page.

Command	Usage
<code>ip dhcp restart</code>	Resubmits a DHCP client request

Security

The **Security** page contains links to the following information:

- 1 Passwords
- 1 RADIUS Settings

Passwords

You should change the default passwords to be sure that your system is secure:

NOTE: The default user names are *admin* and *guest*, and the corresponding passwords are *admin* and *guest*. If you log in as *guest* (Normal Exec level), you can only view page information and change the guest password. If you log in as *admin* (Privileged Exec level), you can apply changes on all pages.

- 1 **Old Password** — Type your current password.
- 1 **New Password** — Type the new password. Passwords are limited to eight characters and are case sensitive.
- 1 **Confirm Password** — Type the new password a second time to verify that you have typed it correctly.

The password entered is encrypted on the screen and is displayed as a sequence of asterisks (*).

To save any changes you make in this page, click **Apply Changes**. If you don't want to save the changes, click **Refresh**.

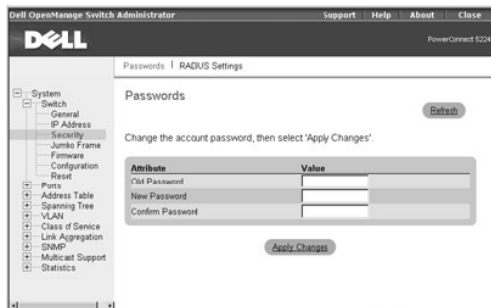

CLI Commands

The following table summarizes the equivalent CLI commands for items in the **Switch/Security/Passwords** page.

Command	Usage
<code>enable password [level level] {0 7} password</code>	Use this command to control access to the Privileged Exec level from the Normal Exec level. For the {0 7} parameter, 0 means plain password and 7 means encrypted password. The Privileged Exec level is 15 and the default password is <i>super</i> .
<code>username name {access-level level nopassword password {0 7} password}</code>	Use this command to configure user name authentication at login. Use the no form command to remove a user name. The device has two predefined privilege levels: 0: Normal Exec and 15: Privileged Exec. The default user names are <i>admin</i> for the Privileged Exec level, and <i>guest</i> for the Normal Exec level.

NOTE: Only the CLI allows user names to be created and deleted.

Example

```
Console(config)#enable password level 15 0 admin

Console(config)#username bob access-level 15

Console(config)#username bob password smith

Console(config)#
```

RADIUS Settings

Remote Authentication Dial-in User Service (RADIUS) is a system that uses a central server running RADIUS software to control access to RADIUS-aware switches on the network. A RADIUS server can be used to create a database of multiple user name/password pairs with associated privilege levels for each user or group that require management access to a switch using the console port, Telnet, or Internet.

When you are setting up privilege levels on the RADIUS server, level 0 allows Normal Exec access to the switch, and level 15 allows Privileged Exec access.

The **RADIUS Settings** page contains the following editable fields:

- 1 **Authentication** — Select the authentication, or authentication sequence, required:
 - o **Radius** — A RADIUS server authenticates the user.
 - o **Local** — The switch authenticates the user.
 - o **Radius, Local** — A RADIUS server attempts to authenticate the user first, and then the switch attempts to authenticate the user.

- o **Local, Radius** — The switch attempts to authenticate the user first, and then a RADIUS server attempts to authenticate the user.
- 1 **Server IP Address** — Identifies the IP address of the RADIUS server.
- 1 **Server Port Number** — Identifies the User Datagram Protocol (UDP) port number used by the RADIUS server.
- 1 **Secret Text String** — Specifies the text string that is shared between the switch and the RADIUS server.
- 1 **Number of Server Transmits** — Specifies the number of request transmits to the RADIUS server before failure.
- 1 **Timeout for a reply (sec)**— Specifies the number of seconds the switch waits for a reply from the RADIUS server before it resends the request.

 **NOTE:** The local switch user database must be set up through the CLI by manually entering user names and passwords.

To save any changes you make in this page, click **Apply Changes**. If you don't want to save the changes, click **Refresh**.

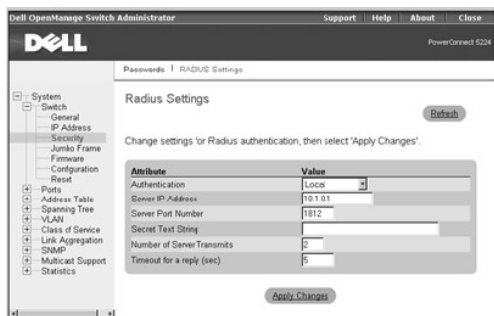

CLI Commands

The following table summarizes the equivalent CLI commands for items in the **Switch/Security/RADIUS Settings** page.

Command	Usage
authentication login {radius local radius local local radius}	Defines the login authentication method and precedence.
radius-server host <i>host_ip_address</i>	Specifies the RADIUS server IP address.
radius-server port <i>port_number</i>	Sets the RADIUS server UDP port number.
radius-server key <i>key_string</i>	Sets the RADIUS encryption key (up to 20 characters).
radius-server retransmit <i>number_of_retries</i>	Sets the number of times the switch attempts to authenticate logon access through the RADIUS server. (The range is 1–30.)
radius-server timeout <i>number_of_seconds</i>	Sets the number of seconds the switch waits for a reply before resending a request. (The range is 1–65535.)

Example

```

Console(config)#authentication login radius

Console(config)#radius-server host 192.168.1.25

Console(config)#radius-server port 181

Console(config)#radius-server key solvent

Console(config)#radius-server retransmit 5

Console(config)#radius-server timeout 10

Console(config)#

```

Jumbo Frame

From the **Jumbo Frame** page, you can enable and disable jumbo frame support on the switch.

The switch provides more efficient large sequential data transfers by supporting jumbo frames up to 9000 bytes. Compared to standard Ethernet frames that run only up to 1500 bytes, using jumbo frames significantly reduces the per-packet overhead required to process protocol encapsulation fields.

To use jumbo frames, both the source and destination end nodes (such as a computer or server) must support jumbo frames. In addition, when the connection is operating at full duplex, all switches in the network between the two end nodes must be able to accept the extended frame size. For half-duplex connections, all devices in the collision domain must support jumbo frames.

To enable jumbo frame support on the switch, set the **Jumbo Frame Support Status** to **Enabled**.

 **NOTICE:** Enabling jumbo frames on the switch limits the maximum threshold for broadcast storm control to 64 packets per second.

To save any changes you make in this page, click **Apply Changes**. If you don't want to save the changes, click **Refresh**.



CLI Commands

The following table summarizes the equivalent CLI command for items in the **Switch/Jumbo Frame** page.

Command	Usage
jumbo frame	Use this command to enable jumbo frames to be forwarded through the switch. Use the no form to disable jumbo frames.

Example

```
Console(config)#jumbo frame
Console(config)#
```

Firmware Upgrade

From the **Firmware** page, you can configure the system to download a new version of the management software. The switch can contain two software code files, one of which is set as the **Start-Up** file. This allows you to try a new version of the software without overwriting the previous version.

 **NOTE:** The switch is shipped with one software code file installed (the filename is similar to **PC5224_v1.00.00.00**), which is set as the start-up file.

The **Firmware** page contains the following fields:

- 1 **Current Operation Code Version**

It also contains the following editable fields:

- 1 **TFTP Server IP Address** — Specifies the server from which the system must retrieve the new version of the software.
- 1 **Source File Name** — Specifies the path and name of the software file to download.
- 1 **Destination File Name** — Specifies the file to be replaced.
- 1 **Remove Operation Code Image File** — Deletes a software file from the switch.
- 1 **Start-Up Operation Code File Name** — Indicates which Operation Code file you want to run. Select the filename from the drop-down menu.

Uploading Operation Code to a Server

1. In the **Transfer Operation Code Image File to Server** field, enter the IP address of the Trivial File Transfer Protocol (TFTP) server in the **TFTP Server IP Address** field.
2. In the **Source File Name** field, select the file to upload from the drop-down menu.
3. In the **Destination File Name** field, type a name for the file.
4. Click **Transfer to Server**.

Downloading Operation Code from a Server

1. In the **Transfer Operation Code Image File from Server** field, enter the IP address of the TFTP server in the **TFTP Server IP Address** field.
2. In the **Source File Name** field, type the filename of the software code file to download.
3. For the **Destination File Name**, select a filename from the drop-down menu to replace an existing file, or specify a new filename (with no more than 32 characters). Filenames are case sensitive and cannot contain spaces. The switch can contain only two software code files. You cannot download a third file; you must first replace an existing file or remove a file.
4. Click **Transfer from Server**.

Deleting an Operation Code File from the Switch

1. In the **Remove Operation Code Image File** field, select the file to delete from the drop-down menu.
2. Click **Remove File**.

Selecting the Operation Code Start-up File

1. In the **Start-Up Operation Code Image File** field, select the start-up code file from the drop-down menu.
2. Click **Apply Changes**.

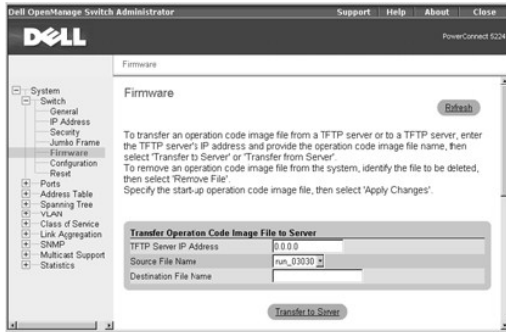

The following table summarizes the equivalent CLI commands for items in the **Switch/Firmware** page.

Command	Usage
copy tftp file	Downloads a code image to the switch's flash memory from a TFTP server
boot system {boot-rom config opcode}: filename	Specifies the file or image used to start up the system
dir [boot-rom config opcode [: filename]]	Displays a list of files in flash memory

 **NOTE:** You cannot upload and download Boot-ROM files to a TFTP server using the CLI. You must use a direct terminal connection to the switch's console port and press <Ctrl><f> after the diagnostic test results. See "[Downloading Firmware Through the Console Port](#)."

Example

```

Console#copy tftp file

TFTP server ip address: 10.1.0.45

Choose file type:

1. config: 2. opcode: <1-2>: 2

Source file name: runtime

Destination file name: 0126.bix

/

Console#
  
```

Configuration

From the **Configuration** page you can save and restore switch configuration settings.

 **NOTE:** The switch is shipped with one default configuration file (**Factory_Default_Config.cfg**) installed, which is set as the start-up file. This file cannot be removed from the system.

The **Configuration** page contains the following editable fields:

- 1 **Transfer Configuration to Server** — Copies a switch configuration file to a TFTP server.
- 1 **Transfer Configuration from Server** — Copies a switch configuration file from a TFTP server.
- 1 **Remove Configuration File** — Deletes a configuration file from the switch (selected from the drop-down menu).
- 1 **Start-Up Configuration File** — Selects the configuration file to be used after a system start-up (selected from the drop-down menu).
- 1 **Copy Running Config to File** — Saves the current session configuration settings. Specifies a new filename or the name of an existing file to be replaced.

 **NOTE:** For configuration changes to persist beyond the current session, you must save the **running-config** file from this page, or use the CLI command **copy running-config startup-config**.

Transferring a Configuration File to a Server

1. In the **Transfer Configuration File to Server** field, enter the IP address of the TFTP server in the **TFTP Server IP Address** field.

2. In the **Source File Name** field, select the configuration file to upload from the drop-down menu.
3. For the **Destination File Name**, type a filename to identify the configuration file on the TFTP server.
4. Click **Transfer to Server**.

Transferring a Configuration File from a Server

1. Under **Transfer Configuration File from Server**, enter the IP address of the TFTP server in the **TFTP Server IP Address** field.
2. In the **Source File Name** field, type the filename of the configuration file to download.
3. In the **Destination File Name** field, select a configuration file to replace from the drop-down menu, or specify a new filename (with no more than 32 characters). Filenames are case sensitive and cannot contain spaces. The switch can contain any number of configuration files, limited only by available flash memory space. You can use the **dir** command in the CLI to check the available flash memory space.
4. Click **Transfer from Server**.

 **NOTE:** The CLI also allows you to copy files within the switch and replace a running configuration file without performing a reset.

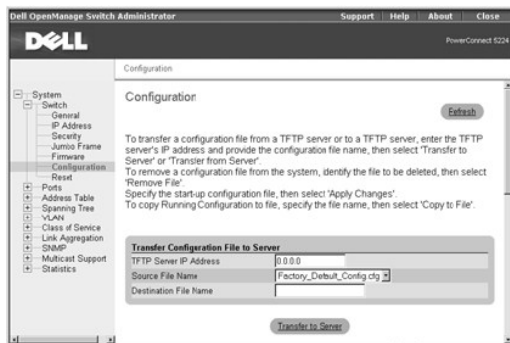

Deleting a Configuration File from the Switch

1. In the **Remove Configuration File** field, select the file to delete from the drop-down menu.
2. Click **Remove File**.

Selecting the Start-up Configuration File

1. In the **Start-Up Configuration File** field, select the start-up configuration file from the drop-down menu.
2. Click **Apply Changes**.

Copying the Running Configuration to a File

1. In the **Copy Running Config to File** field, specify a filename for the configuration file (with no more than 32 characters). If the filename already exists, it replaces the file. The filename cannot be the same as the factory default configuration file, **Factory_Default_Config.cfg**.
2. Click **Copy to File**.

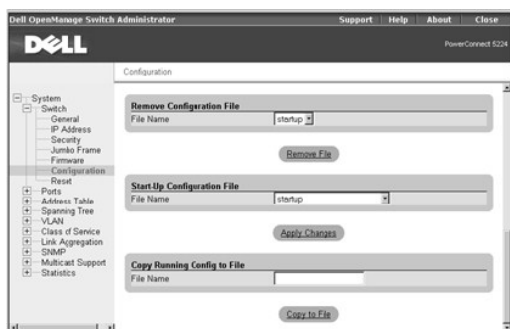

CLI Commands

The following table summarizes the equivalent CLI commands for items in the **Switch/Configuration** web page.

Command	Usage
copy file {file running-config startup-config tftp}	Uploads/downloads a configuration file to/from the switch's flash memory to a TFTP server

boot system {boot-rom config opcode}: filename	Specifies the file or image used to start up the system
---	---

Example

```

Console#copy tftp startup-config

TFTP server ip address: 10.1.0.99

Source configuration file name: startup.01

Startup configuration file name [startup]:

/

Console#

```

Reset

Click **Reset** to reboot the switch. When prompted, confirm that you want to reset the switch.

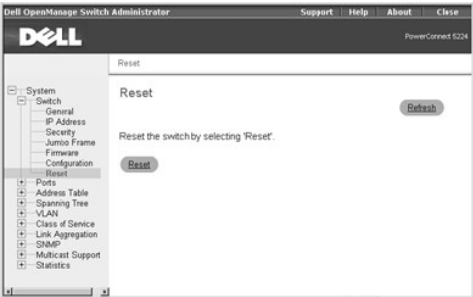

CLI Commands

The following table summarizes the equivalent CLI command for items in the **Switch/Reset** page.

Command	Usage
reload	Restarts the system

Example

```

Console#reload

System will be restarted, continue <y/n>? y

Console#

```

Ports

The Port Manager contains links to the following options:

- 1 **Port Configuration**
- 1 **Trunk Configuration**
- 1 **Broadcast Control**
- 1 **Port Mirroring**

Port Configuration

On the **Port Configuration** page, you can view and edit port parameters. For each port number listed in the **Port** column, you can change the following parameters listed by column name on the screen:

- 1 **Name/Type** — Allows a user-defined label for the port and indicates the type of port:
 - o **1000Base-TX** — 10/100/1000Base-T RJ-45 port
 - o **1000Base-SFP** — gigabit SFP transceiver port
- 1 **Admin/Oper** — Allows the network administrator to manually disable a port and indicates the status of the link: up or down.
- 1 **Speed/Duplex Mode** — Allows the manual selection of port speed and duplex mode and indicates the current port speed and mode.

- 1 **Flow Control** — Allows automatic or manual selection of support for flow control and indicates the type of flow control currently in use.
- 1 **Autonegotiation/Port Capabilities** — Allows autonegotiation to be enabled/disabled and indicates the capabilities of the port that are advertised during autonegotiation:
 - o **10h** — Supports 10-megabits per second (Mbps) half duplex.
 - o **10f** — Supports 10-Mbps full duplex.
 - o **100h** — Supports 100-Mbps half duplex.
 - o **100f** — Supports 100-Mbps full duplex.
 - o **1000h** — Supports 1000-Mbps half duplex.
 - o **1000f** — Supports 1000-Mbps full duplex.
 - o **Sym** — Supports symmetric operation of full-duplex flow control. The port can transmit and receive pause frames for flow control (gigabit ports only).
 - o **FC** — Supports full-duplex flow control.
- 1 **Trunk** — Indicates whether a port is a member of an aggregated link or trunk.

➔ **NOTICE:** If autonegotiation is disabled for an RJ-45 port, the auto-MDI/MDI-X pin signal configuration is also disabled.

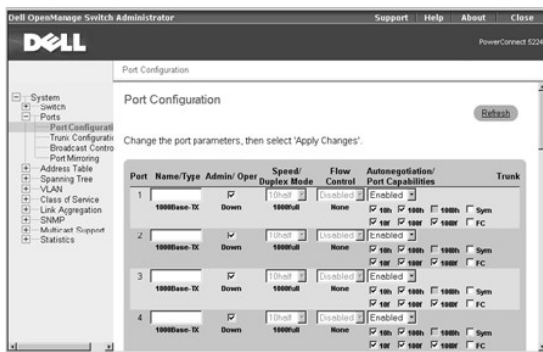

CLI Commands

The following table summarizes the equivalent CLI commands for items in the **Ports/Port Configuration** page.

Command	Usage
interface ethernet <i>unit/port</i>	Configures an Ethernet port interface and enters interface configuration mode.
shutdown	Disables an interface. To restart a disabled interface, use the no form command.
description <i>string</i>	Adds a description to an interface.
speed-duplex { 1000full 100full 100half 10full 10half }	Configures the speed and duplex mode of a given interface when autonegotiation is disabled.
negotiation	Enables autonegotiation for a given interface. Use the no form command to disable autonegotiation.
capabilities { 1000full 100full 100half 10full 10half flowcontrol symmetric }	Advertises the port capabilities of a given interface during autonegotiation. Use the no form with parameters command to remove an advertised capability, or the no form without parameters command to restore the default values.
flowcontrol	Enables flow control. Use the no form command to disable flow control.
show interfaces status ethernet <i>unit/port</i>	Displays status for enabled interfaces.
show interfaces switchport [ethernet <i>unit/port</i>]	Displays the configuration for a port.

➔ **NOTICE:** Flow control only works for ports connected to the same internal switch chip (ports 1 to 12 and ports 13 to 24). Cross-chip flow control does not work.

Example

```
Console(config)#interface ethernet 1/5
```

```

Console(config-if)#

Console(config-if)#description RD SW#3

Console(config-if)#no negotiation

Console(config-if)#speed-duplex 100half

Console(config-if)#flowcontrol

```

Trunk Configuration

On the **Trunk Configuration** page, you can enable and disable the aggregate port links that have been created on the switch. To set up trunks and select port members, use the **Link Aggregation** page.

For each trunk number listed in the **Trunk** column, you can change the following parameters listed by column name on the screen:

- 1 **Name/Type** — Allows a user-defined label for the trunk and also indicates the type of ports in the trunk
- 1 **Admin/Oper** — Allows the network administrator to manually disable a trunk and also indicates the status of the link: up or down
- 1 **Speed/Duplex Mode** — Allows the manual selection of port speed and duplex mode and also indicates the current speed and mode of member ports
- 1 **Flow Control** — Allows automatic or manual selection of support for flow control and also indicates the type of flow control currently in use
- 1 **Autonegotiation/Port Capabilities** — Allows autonegotiation to be enabled/disabled for all ports in the trunk and also indicates the capabilities of the port members

To save any changes you make in this page, click **Apply Changes**. If you don't want to save the changes, click **Refresh**.

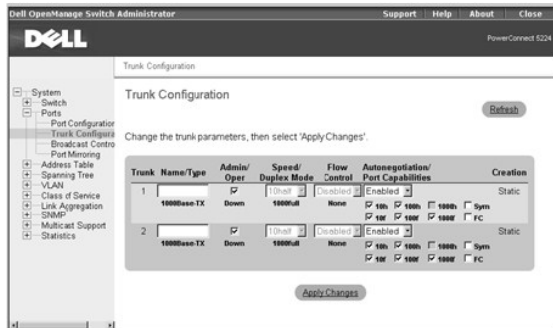

CLI Commands

The following table summarizes the equivalent CLI commands for items in the **Ports/Trunks Configuration** page.

Command	Usage
interface port-channel <i>channel-id</i>	Configures a trunk and enters interface configuration mode.
shutdown	Disables a trunk interface. To restart a disabled interface, use the no form command.
description <i>string</i>	Adds a description to a trunk interface.
speed-duplex {1000full 100full 100half 10full 10half}	Configures the speed and duplex mode of a given interface when autonegotiation is disabled.
negotiation	Enables autonegotiation for a given interface. To disable autonegotiation, use the no form command.
capabilities {1000full 100full 100half 10full 10half flowcontrol symmetric}	Advertises the trunk capabilities of a given interface during autonegotiation.
flowcontrol	Enables flow control. To disable flow control, use the no form command.
show interfaces status port-channel <i>channel-id</i>	Displays status for enabled interfaces.
show interfaces switchport [port-channel <i>channel-id</i>]	Displays the configuration for a trunk.

Example

```

Console(config)#interface port-channel 1

Console(config-if)#

Console(config-if)#description RD SW#3

```

```

Console(config-if)#no negotiation

Console(config-if)#speed-duplex 100half

Console(config-if)#flowcontrol

```

Broadcast Control

In the **Broadcast Control** page, you can enable and disable broadcast control for all ports on the switch.

The **Broadcast Control** page contains the following information:

- 1 **Port Number**
- 1 **Port Type:**
 - o **1000Base-TX** — 10/100/1000Base-T RJ-45 port
 - o **1000Base-SFP** — gigabit SFP transceiver port

The **Broadcast Control** page also contains the following editable fields:

- 1 **Protect Status** — Allows you to enable/disable broadcast storm control for ports on the switch. When enabled, the switch employs a broadcast-control mechanism if the packet-per-second threshold on a port is exceeded. (The default is enabled.)
- 1 **Threshold (16,64,128,256)** — The packet-per-second threshold for broadcast packets received on a port. Possible values are 16, 64, 128, or 256 packets per second. (The default is 256 packets per second.) If jumbo frames are enabled on the switch, the maximum threshold for broadcast storm control is limited to 64 pps.

 **NOTICE:** You can enable/disable broadcast storm control on a per-port basis, but the selected packet-per-second threshold applies to all ports on the switch.

To save any changes you make in this page, click **Apply Changes**. If you don't want to save the changes, click **Refresh**.

 **NOTE:** Broadcast control does not affect IP multicast traffic.

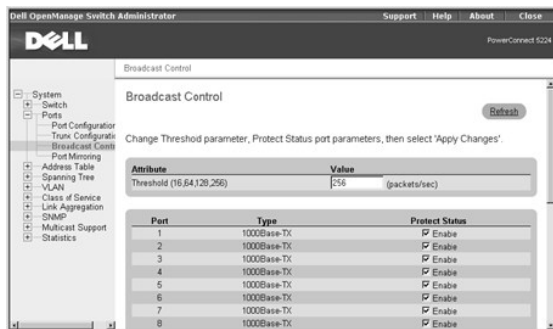

CLI Commands

The following table summarizes the equivalent CLI command for items in the **Ports/Broadcast Control** web page.

Command	Usage
switchport broadcast packet-rate <i>rate</i>	Configures broadcast storm control (applies to all ports)

Example

```

Console(config)#interface ethernet 1/5

Console(config-if)#switchport broadcast packet-rate 64

Console(config-if)#

```

Port Mirroring

From the **Port Mirroring** page, you can configure a port mirror session by setting a source and destination port pair. Port mirroring helps you debug a network.

 **NOTICE:** You can configure only one port mirror session on the switch. The source and destination port have to be either both in the port range of 1 to 12 or both in the port range of 13 to 24.

The following options are available:

- 1 **Sessions Table** — Displays the current port mirror session

- 1 **Source Port** — Specifies the port from which all traffic will be mirrored to the destination port
- 1 **Type** — Allows you to select which traffic to mirror to the destination port: **Rx**, **Tx**, or **Both**
- 1 **Destination Port** — Specifies the port that receives a copy of all traffic that the source port receives or transmits

 **NOTE:** The source port and destination port speeds must match. Otherwise traffic may be dropped from the destination port.

To add a new mirror session to the **Sessions Table**, first delete the current mirror session by selecting the session in the table and clicking **Remove Mirror Session**. Select the new source port, destination port, and traffic type, and then click **Add Mirror Session**.

 **NOTE:** The source and destination ports must both either be in the range of 1 to 12 or 13 to 24.

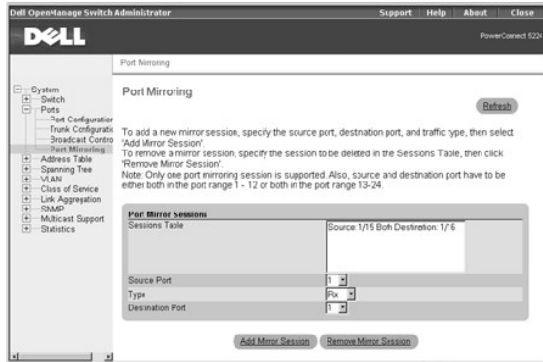

CLI Commands

The following table summarizes the equivalent CLI commands for items in the **Ports/Port Mirroring** page.

Command	Usage
port monitor <i>interface</i> [rx tx both]	Configures a mirror session
show port monitor [<i>interface</i>]	Displays mirror information

Example

```
Console(config)#interface ethernet 1/6
Console(config-if)#port monitor ethernet 1/5 both
Console(config-if)#
```

Address Table

The **Address Table** page includes links to the following pages:

- 1 **Static Addresses**
- 1 **Dynamic Addresses**
- 1 **Address Aging**

Static Addresses

From the **Static Addresses** page, you can specify the Media Access Control (MAC) address and port number of systems that are to remain available to the switch for an indeterminate amount of time.

The following options are available:

- 1 **Static Address Counts** — Indicates the total number of static addresses configured on the switch
- 1 **Current Static Address Table** — Lists all static addresses
- 1 **Interface** — Allows you to select the port or trunk associated with the system you want to set as static
- 1 **MAC Address** — Allows you to enter the MAC address of a system you want to set as static
- 1 **VLAN** — Allows you to select the VLAN associated with the interface

To add a new address to the table, select the interface, MAC address, and VLAN, and then click **Add Static Address**. To delete an address from the table, select the table entry in the list box, and then click **Remove Static Address**.



CLI Commands

The following table summarizes the equivalent CLI commands for items in the **Address Table/Static Addresses** page.

Command	Usage
bridge <i>bridge-group</i> address <i>mac-address</i> vlan <i>vlan-id</i> forward <i>interface</i> [<i>action</i>]	Maps a static address to a port in a VLAN The <i>action</i> parameters are: delete-on-reset: Assignment lasts until switch is reset permanent: Assignment is permanent
show bridge <i>bridge-group</i> [<i>interface</i>] [<i>address</i> [<i>mask</i>]] [<i>vlan</i> <i>vlan-id</i>] [sort { <i>address</i> <i>vlan</i> <i>interface</i> }]	Allows you to view classes of entries in the bridge-forwarding database

Example

```
Console(config)#bridge 1 address 00-e0-29-94-34-de vlan 1 forward ethernet 1/1 delete-on-reset
Console(config)#
```

Dynamic Addresses

The Dynamic Address lookup table allows you to view the MAC addresses that are currently in the address database. When addresses are in the database, the packets intended for those addresses are forwarded directly to those ports. You can sort the table by interface, VLAN, and MAC address by selecting the sort key from the drop-down menu.

The **Dynamic Addresses** page contains the following options for querying the dynamic MAC address table:

- 1 **Interface** — Check the option box and select a port or trunk from the drop-down menu.
- 1 **MAC Address** — Check the option box and type the address in the box provided.
- 1 **VLAN** — Check the option box and select the appropriate VLAN from the drop-down menu.
- 1 **Address Table Sort Key** — Select the key from the drop-down menu to sort the displayed table entries.
- 1 **Query** button — Click this button to execute the query once you have selected the criteria for the query.

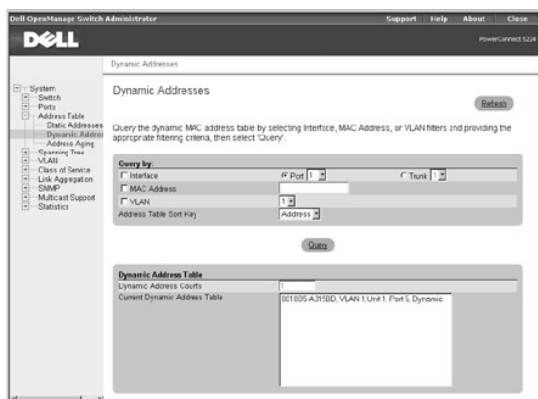

CLI Commands

The following table summarizes the equivalent CLI command for items in the **Address Table/Dynamic Addresses** page.

Command	Usage
show bridge <i>bridge-group</i> [<i>interface</i>] [<i>address</i> [<i>mask</i>]] [<i>vlan</i> <i>vlan-id</i>] [<i>sort</i> { <i>address</i> <i>vlan</i> <i>interface</i> }]	Allows you to view classes of entries in the bridge-forwarding database

Example

```

Console#show bridge 1

Interface Mac Address      Vlan Type
-----
Eth 1/11 00-10-b5-62-03-74 1    Learned

Console#

```

Address Aging

In the **Address Aging** page, you can specify the length of time an address stays available to the switch if it is not configured as static.

The **Aging Time** option sets the time before an address is purged from the system. You can change this value to any number between 17 and 2184. (The default is 300 seconds.)

To save any changes you make in this page, click **Apply Changes**. If you don't want to save the changes, click **Refresh**.



CLI Commands

The following table summarizes the equivalent CLI command for items in the **Address Table/Address Aging** page.

Command	Usage
bridge-group <i>bridge-group</i> aging-time <i>seconds</i>	Sets the aging time for entries in the address table

Example

```

Console(config)#bridge-group 1 aging-time 300

Console(config)#

```

Spanning Tree

The **Spanning Tree** page contains links to pages that allow you to specify the parameters of the Spanning Tree Protocol:

- 1 **Bridge Settings**
- 1 **Port Settings**
- 1 **Trunk Settings**

Bridge Settings

The **Bridge Settings** page contains the following information:

- 1 **Bridge ID** — Identifies a unique identifier for the switch in the Spanning Tree. The ID is calculated using the defined Spanning Tree priority of the switch and its MAC address. The lower the Bridge ID, the more likely the switch will act as the root.
- 1 **Max Age** — Specifies the maximum time (in seconds) that the switch waits before attempting to reconfigure (if it has not received a configuration message).
- 1 **Hello Time** — Specifies the time interval (in seconds) at which the root device transmits a configuration message.

- 1 **Forward Delay** — Specifies the maximum time (in seconds) the root device waits before changing states (from listening to learning to forwarding).
- 1 **Designated Root** — Identifies the priority and MAC address of the device in the Spanning Tree that the switch has accepted as the root device.
- 1 **Root Port** — Specifies the port number on the switch that is closest to the root. The switch communicates with the root device through this port. If there is no root port, the switch has been accepted as the root device of the Spanning Tree network.
- 1 **Root Path Cost** — Identifies the path cost from the root port on the switch to the root device.
- 1 **Configuration Changes** — Specifies the number of times the Spanning Tree has been reconfigured.
- 1 **Last Topology Change** — Identifies the time since the Spanning Tree was last reconfigured.

From the **Bridge Settings** page, under **Attributes**, you can also enable and configure the following Spanning Tree parameters:

- 1 **Spanning Tree State** — Enables or disables the Spanning Tree. If you enable the Spanning Tree, you must complete the other fields.
- 1 **Priority** — Sets the priority setting among other switches in the Spanning Tree. (The range is 0 to 65535.)
- 1 **Hello Time** — Sets the interval between configuration messages sent by the Spanning Tree Protocol. (The range is 1 to 10 seconds.)
- 1 **Maximum Age** — Sets the amount of time before the system discards a configuration message. (The range is 6 to 40 seconds.)
- 1 **Forward Delay** — Sets the amount of time the system spends in *learning* and *listening* states. (The range is 4 to 30 seconds.)

To save any changes you make in this page for the current session, click **Apply Changes**. If you don't want to save the changes, click **Refresh**.

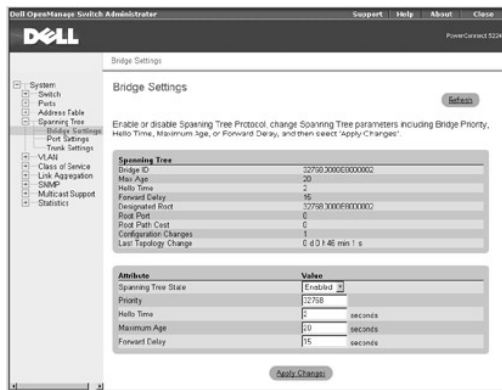

CLI Commands

The following table summarizes the equivalent CLI commands for items in the **Spanning Tree/Bridge Settings** page.

Command	Usage
bridge <i>bridge-group</i> spanning-tree	Enables the spanning tree algorithm globally for the switch. Use the no form command to disable it.
bridge <i>bridge-group</i> forward-time <i>seconds</i>	Configures the spanning tree bridge forward time globally for the switch.
bridge <i>bridge-group</i> hello-time <i>time</i>	Configures the spanning tree bridge hello time globally for the switch.
bridge <i>bridge-group</i> max-age <i>seconds</i>	Configures the spanning tree bridge maximum age globally for the switch.
bridge <i>bridge-group</i> priority <i>priority</i>	Configures the spanning tree priority globally for the switch.
show bridge group <i>bridge-group</i> [<i>interface</i>]	Shows the spanning tree configuration.

Example

```

Console(config)#bridge 1 spanning-tree

Console(config)#bridge 1 forward-time 15

Console(config)#bridge 1 hello-time 2

Console(config)#bridge 1 max-age 20

Console(config)#bridge 1 priority 40000

```

Port Settings

In the **Port Settings** page, you can specify Spanning Tree parameters for each port. For each port number listed in the **Port** column, the following information is available:

- 1 **Type** — Specifies the type of port, indicates one of the following:
 - o **1000Base-TX** — 10/100/1000Base-T RJ-45 port
 - o **1000Base-SFP** — gigabit SFP transceiver port
- 1 **State** — Displays the current state of the port within the Spanning Tree:
 - o **No Link** — No valid link on the port.
 - o **Disabled** — Port has been disabled by the user or has failed diagnostics.
 - o **Blocking** — Port receives Spanning Tree configuration messages, but does not forward packets.
 - o **Listening** — Port leaves blocking state due to topology change, starts transmitting configuration messages, but does not forward packets.
 - o **Learning** — Port has transmitted configuration messages for an interval set by the Forward Delay parameter without receiving contradictory information. The port address table is cleared, and the port begins learning addresses.
 - o **Forwarding** — Port forwards packets and continues learning addresses.
- 1 **Trunk** — Indicates whether the port is configured as a trunk member

The **Port Settings** page also contains the following editable fields:

- 1 **Priority** — Indicates the priority assigned to the port for the Spanning Tree Protocol (0 to 255). A port with a higher priority is less likely to be blocked if the Spanning Tree Protocol detects network loops. Low numeric value indicates a high priority.
- 1 **Path Cost** — Specifies the cost assigned to this port for the Spanning Tree Protocol (1 to 65535). A port with a lower cost is less likely to be blocked if the Spanning Tree Protocol detects network loops.

 **NOTE:** Use Fast Link if a device is connected to a port that requires network access immediately when the link comes up and cannot wait for a Spanning Tree resolution.

- 1 **Fast Link** — Immediately enables the port in forwarding state when a link comes up. The port is not part of the Spanning Tree at that time, but will participate in future Spanning Tree resolutions.

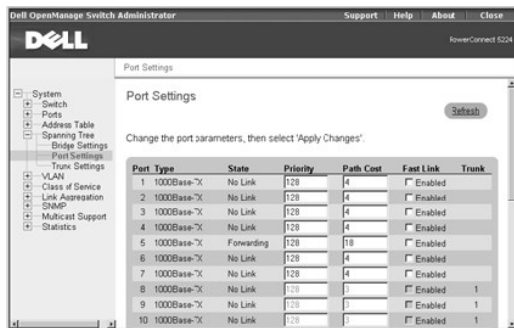

CLI Commands

The following table summarizes the equivalent CLI commands for items in the **Spanning Tree/Port Settings** page.

Command	Usage
<code>bridge-group <i>bridge-group</i> path-cost <i>cost</i></code>	Configures the spanning tree path cost for the specified port
<code>bridge-group <i>bridge-group</i> priority <i>priority</i></code>	Configures the priority for the specified port
<code>bridge-group <i>bridge-group</i> portfast</code>	Sets a port to fast forwarding state

Example

```

Console(config)#interface ethernet 1/5

Console(config-if)#bridge-group 1 path-cost 50

Console(config-if)#bridge-group 1 priority 0

Console(config-if)#bridge-group 1 portfast

```

Trunk Settings

On the **Trunk Settings** page, you can specify Spanning Tree parameters for each trunk. For each port number listed in the **Trunk** column, the following fields are available:

- 1 **Priority** — Indicates the priority assigned to the trunk for the Spanning Tree Protocol (0 to 255). A trunk with a higher priority is less likely to be blocked if the Spanning Tree Protocol detects network loops. Low numeric value indicates a high priority.
- 1 **Path Cost** — Specifies the cost assigned to the trunk for the Spanning Tree Protocol (1 to 65535). A trunk with a lower cost is less likely to be blocked if the Spanning Tree Protocol detects network loops.

 **NOTE:** Use Fast Link if a device is connected to a trunk that requires network access immediately when the link comes up and cannot wait for a Spanning Tree resolution.

- 1 **Fast Link** — Immediately enables the trunk in forwarding state when a link comes up. The trunk is not part of the Spanning Tree at that time, but will participate in future Spanning Tree resolutions.

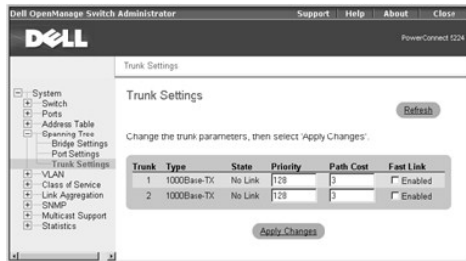

CLI Commands

The following table summarizes the equivalent CLI commands for items in the **Spanning Tree/Trunk Settings** page.

Command	Usage
bridge-group <i>bridge-group</i> path-cost <i>cost</i>	Configures the spanning tree path cost for the specified trunk
bridge-group <i>bridge-group</i> priority <i>priority</i>	Configures the priority for the specified trunk
bridge-group <i>bridge-group</i> portfast	Sets a trunk to fast forwarding state

Example

```

Console(config)#interface port-channel 1

Console(config-if)#bridge-group 1 path-cost 50

Console(config-if)#bridge-group 1 priority 0

Console(config-if)#bridge-group 1 portfast

```

VLAN

You can use virtual LANs (VLANs) to assign ports on the switch to any of up to 255 LAN groups. In conventional networks with routers, broadcast and multicast traffic is split up into separate domains. Switches do not inherently support broadcast domains, which can lead to broadcast storms in large networks. By using IEEE 802.1Q-compliant VLANs and GARP VLAN Registration Protocol (GVRP), you can organize any group of network nodes into separate broadcast domains, confining broadcast and multicast traffic to the originating group. This also provides a more secure and cleaner network environment. For more information on how to use VLANs, see "[VLANs](#)."

The **VLAN** page includes links to the following pages:

- 1 **VLAN Membership**
- 1 **Port Settings**
- 1 **Trunk Settings**
- 1 **GVRP**

VLAN Membership

On the **VLAN Membership** page, you define VLAN groups. The following options are available:

- 1 **Show VLAN** — Select the VLAN for which you want to edit the membership setting.
- 1 **Name** — Specifies user-defined name of the VLAN.
- 1 **VLAN ID** — Specifies numeric ID of the VLAN (1 to 4094).
- 1 **Remove VLAN** — Check this box to remove an existing VLAN.
- 1 **Status** — Configures the VLAN as **Active** or **Suspended**.
- 1 **Creation** — Indicates whether the VLAN has been created as a permanent (static) VLAN or has been dynamically created through GVRP.
- 1 **Port/Trunk** toggle buttons — Allows you to select VLAN membership for each port or trunk by toggling the value of the **Port/Trunk** button:
 - o **'U'**: Port is a member of the VLAN. All packets transmitted by the port will be untagged, that is, not carry a tag and therefore not carry VLAN or CoS information.
 - o **'T'**: Port is a member of the VLAN. All packets transmitted by the port will be tagged, that is, carry a tag and, therefore, carry VLAN or CoS information.

- o 'F': Port is forbidden from automatically joining the VLAN through GVRP. For more information, see "[GVRP](#)."
- o 'BLANK': Port is not a member of the VLAN. Packets associated with this VLAN will not be transmitted by the port.

The VLAN tagging option is a standard set by the IEEE to facilitate the spanning of VLANs across multiple switches. For more information, see "[VLANs](#)" and the IEEE Std 802.1Q-1998 Virtual Bridged Local Area Networks.

To save any changes you make in this page, click **Apply Changes**. If you don't want to save the changes, click **Refresh**.

Adding VLAN Group

1. Select **Add a new VLAN** from the **Show VLAN** drop-down menu.
2. Complete the **VLAN Name** and **VLAN ID** fields.
3. Add VLAN members.

See "[VLAN Membership](#)" for more information on VLAN members.

4. Click **Apply Changes**.

Removing VLAN Group

 **NOTE:** If you remove a VLAN group with existing port members, the ports will rejoin the default VLAN in untagged mode.

1. Select the VLAN that you want to remove from the **Show VLAN** drop-down menu.
2. Check the **Remove VLAN** box for the VLAN that you want to remove.
3. Click **Apply Changes**.

Adding VLAN Membership

1. Select the VLAN that you want to edit from the **Show VLAN** drop-down menu.
2. Change the VLAN member by clicking the port icon until the desired state [**T** (tagged) or **U** (untagged)] or a blank appears.
3. Click **Apply Changes**.

Removing VLAN Membership

1. Select the VLAN that you want to edit under the **Show VLAN** drop-down menu.
2. Change the VLAN member by clicking the port icon until the field is blank.
3. Click **Apply Changes**.

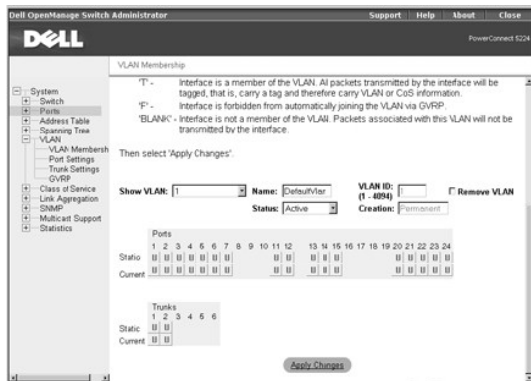

CLI Commands

The following table summarizes the equivalent CLI commands for items in the **VLAN/VLAN Membership** page.

Command	Usage
vlan database	Allows you to enter VLAN database mode.
vlan <i>vlan-id</i> [name <i>vlan-name</i>] media ethernet [state {suspend active}]	Configures a VLAN. Use the no form command to restore the default or delete a VLAN.
interface vlan <i>vlan-id</i>	Allows you to enter interface configuration mode for VLANs and to configure a physical interface.
switchport allowed vlan { add <i>vlan-list</i> [tagged untagged] remove <i>vlan-list</i> }	Configures untagged and tagged ports. The parameter <i>vlan-list</i> is the list of VLAN identifiers being added. Separate nonconsecutive VLAN identifiers with a comma and no spaces;

	use a hyphen to designate a range of IDs.
switchport forbidden vlan { add <i>vlan-list</i> remove <i>vlan-list</i> }	Configures forbidden VLANs for a port.
show vlan [id <i>vlan-id</i> name <i>vlan-name</i>]	Shows VLAN information.

Example

```

Console(config)#vlan database

Console(config-vlan)#vlan 105 name RD5 media ethernet

Console(config-vlan)#exit

Console(config)#interface ethernet 1/1

Console(config-if)#switchport allowed vlan add 105,7,9 tagged

Console(config-if)#exit

Console(config)#exit

Console#show vlan id 105

VLAN Name      Status      Ports/Channel groups
-----
105 RD5        active      Eth1/ 1 Eth1/ 2 Eth1/ 3 Eth1/ 4 Eth1/ 5
                                     Eth1/ 6 Eth1/ 7 Eth1/ 8 Eth1/ 9 Eth1/10

Console#

```

Port Settings

On the **Port Settings** page, you can specify the default port VLAN ID (PVID) for each port on your switch. All untagged packets entering the switch are tagged by default with the ID specified by the port's PVID.

The **Port Settings** page is set up in a table format. For each port listed in the **Port** column, the following options are available:

- PVID** — Specifies the VLAN ID assigned to untagged frames received on the port. To assign a VLAN ID as the port's PVID, the port must be an untagged VLAN member.
- Acceptable Frame Type** — Allows you to set the switch port to accept all frame types, including VLAN tagged or VLAN untagged frames, or only tagged frames.
- Ingress Filtering** — Discards incoming frames for VLANs that do not include the ingress port in their member set, if enabled.
- GVRP Status** — Enables/disables GVRP (GARP VLAN Registration Protocol) for the port. GVRP defines a way for switches to exchange VLAN information to automatically register VLAN members on ports across the network. GVRP must be globally enabled for the switch before you can individually enable GVRP for a specific port. For more information, see "[GVRP](#)."
- GARP Join Timer** — Specifies the interval (in centiseconds) between transmitting requests/queries to participate in a VLAN group. (The range is 20 to 1000 centiseconds.)
- GARP Leave Timer** — Specifies the interval (in centiseconds) a port waits before leaving a VLAN group. This time should be set to more than twice the join time. This interval ensures that after a Leave or LeaveAll message has been issued, the applicants can rejoin before the port actually leaves the group. (The range is 60 to 3000 centiseconds.)
- GARP LeaveAll Timer** — Specifies the interval (in centiseconds) between sending out a LeaveAll query message for VLAN group participants and the port leaving the group. This interval should be considerably larger than the Leave Time to minimize the amount of traffic generated by nodes rejoining the group. (The range is 500 to 18000 centiseconds.)

To save any changes you make in this page, click **Apply Changes**. If you don't want to save the changes, click **Refresh**.

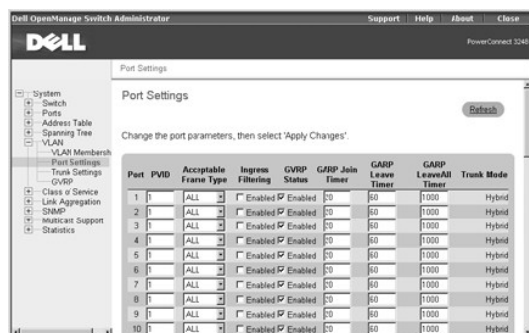

CLI Commands

The following table summarizes the equivalent CLI commands for items in the **VLAN/Port Settings** page.

Command	Usage
switchport native vlan <i>vlan-id</i>	Configures the PVID (default VLAN ID) for a port
switchport acceptable-frame-types {all tagged}	Configures the acceptable frame types for a port
switchport ingress-filtering	Enables ingress filtering for a port
switchport gvrp	Enables GVRP for a port
garp timer {join leave leaveall} <i>timer_value</i>	Sets the values for the GVRP join, leave, and leaveall timers
show gvrp configuration [<i>interface</i>]	Shows whether GVRP is enabled

Example

```

Console(config)#interface ethernet 1/1

Console(config-if)#switchport native vlan 3

Console(config-if)#switchport acceptable-frame-types tagged

Console(config-if)#switchport ingress-filtering

Console(config-if)#

```

Trunk Settings

On the **Trunk Settings** page, you can specify the default port VLAN ID (PVID) for ports that are configured as trunk members. When an untagged packet enters the switch, it is, by default, tagged with the ID specified by the port's PVID.

For each trunk listed in the **Trunk** column, the following options are available:

- 1 **PVID** — Identifies the VLAN ID assigned to untagged frames that are received on each trunk port. To assign a VLAN ID as the port's PVID, the port must be an untagged VLAN member.
- 1 **Acceptable Frame Type** — Sets the switch trunk ports to accept either both tagged and untagged frames or only tagged frames.
- 1 **Ingress Filtering** — Discards incoming frames for VLANs that do not include the trunk in their member set at the ingress ports, if enabled.
- 1 **GVRP Status** — Enables/disables GARP VLAN Registration Protocol (GVRP) for the trunk. GVRP defines a way for switches to exchange VLAN information to automatically register VLAN members on ports across the network. GVRP must be globally enabled for the switch before you can individually enable GVRP for a specific trunk. For more information, see "[GVRP](#)."
- 1 **GARP Join Timer** — Specifies the interval (in centiseconds) between transmitting requests/queries to participate in a VLAN group. (The range is 20 to 1000 centiseconds.)
- 1 **GARP Leave Timer** — Specifies the interval (in centiseconds) that a trunk waits before leaving a VLAN group. GARP Leave Timer should be set to more than twice the join time. This interval ensures that after a Leave or LeaveAll message has been issued, the applicants can rejoin before the trunk actually leaves the group. (The range is 60 to 3000 centiseconds.)
- 1 **GARP LeaveAll Timer** — Specifies the interval (in centiseconds) between when a LeaveAll query message for VLAN group participants is sent and when the trunk leaves the group. This interval should be considerably larger than the Leave Time to minimize the amount of traffic generated by nodes rejoining the group. (The range is 500 to 18000 centiseconds.)

To save any changes you make in this page, click **Apply Changes**. If you don't want to save the changes, click **Refresh**.

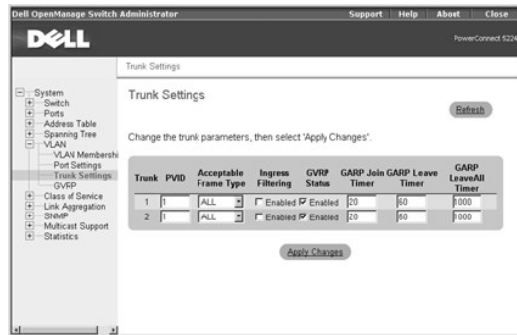

GVRP

The **GVRP** page allows you to globally enable GVRP (GARP VLAN Registration Protocol) for the switch. GVRP defines a way for switches to exchange VLAN information to register VLAN members on ports across the network. You can use GVRP to set up VLANs in the network without having to manually configure the VLANs on each switch. GVRP can reduce the possibility of errors and ensure consistency in VLAN configuration throughout the network.

If you enable GVRP on a port with a tagged or untagged static VLAN, GVRP sends advertisements (GVRP Bridge Protocol Data Units [BPDUs]) containing the VLAN's ID. Any connected GVRP-aware port receiving the advertisements can dynamically join the advertised VLAN. All GVRP dynamically-learned VLANs operate as tagged VLANs. A GVRP-enabled port only joins a VLAN when an advertisement for that VLAN is received on that specific port. A GVRP-enabled port

forwards advertisements from other ports on the switch but does not join the advertised VLAN.

To implement GVRP in a network, you must first configure the static VLANs required on switches that are connected to computers, servers, and other devices, so that these VLANs can be propagated across the network. For other core switches in the network, enable GVRP on the links between these devices. You should also determine security boundaries in the network and configure GVRP settings to limit the VLAN propagation.

When GVRP is globally enabled for the switch, the default setting allows all the ports to transmit and receive VLAN advertisements, as well as automatically join VLANs. To control and limit the VLAN propagation in a network, you can disable GVRP on ports to prevent advertisements from being propagated, or to forbid ports from joining specific VLANs. The **VLAN Membership** page allows you to set ports as **Forbidden**, which prevents them from joining a VLAN through GVRP.

- ➔ **NOTICE:** GVRP-learned VLANs on the switch do not have assigned IP addresses. Therefore, the management VLAN must be statically configured on all switches in the network before you implement GVRP.

For more information on VLANs and GVRP see "[VLANs](#)."

- ➔ **NOTICE:** GVRP must be globally enabled for the switch before you can individually enable GVRP for a specific port or trunk.

To save any changes you make in this page, click **Apply Changes**. If you don't want to save the changes, click **Refresh**.



CLI Commands

The following table summarizes the equivalent CLI commands for items in the **VLAN/GVRP** page.

Command	Usage
bridge-ext gvrp	Enables GVRP for the switch. Use the no form command to disable it.
show gvrp configuration [<i>interface</i>]	Shows whether GVRP is enabled.

Example

```
Console(config)#bridge-ext gvrp  
  
Console(config)#
```

Class of Service

Class of Service (CoS) allows you to assign priority to data packets when traffic in the switch is buffered due to congestion. This switch supports CoS by using four priority queues for each port. Data packets in a port's high-priority queue will be transmitted before packets in the lower-priority queues.

The **Class of Service** page allows you to set the default priority for each port or trunk, and to configure the mapping of frame priority tags to the switch's four priority queues. The page includes links to the following options:

- 1 **Port Settings** — Sets the default priority for each port
- 1 **Trunk Settings** — Sets the default priority for each trunk
- 1 **Traffic Classes** — Configures the mapping of IEEE 802.1p priority tags to the switch's four traffic class queues
- 1 **Queue Scheduling** — Configures Weighted Round Robin (WRR) queuing for the switch ports
- 1 **Layer 3/4 Priority** — Configures the mapping of IP Precedence/DSCP values or IP TCP/UDP port numbers to the switch's four priority queues

- ➔ **NOTICE:** The IEEE 802.1p tags specify eight levels of priority, from the lowest (0) to the highest (7). IP Precedence or IP DSCP values are mapped to these priority tag levels, and the priority levels are mapped directly to the switch's four traffic class queues.

Port Settings

In the **Port Settings** page, you can specify the default port priority for each port on the switch. All packets entering the switch that are untagged (do not already have a priority value) are tagged with the specified default port priority and then sorted into the appropriate priority queue at the output port.

For each port listed in the **Port** column, you can assign the default port priority (from 0 to 7) to untagged frames received on the port. The default setting for

ports is 0.

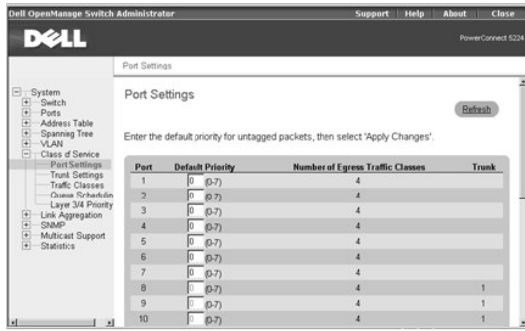

CLI Commands

The following table summarizes the equivalent CLI command for items in the **Class of Service/Port Settings** page.

Command	Usage
switchport priority default <i>default-priority-id</i>	Sets a priority for the incoming untagged frames or the priority of frames received by the device connected to the specified interface

Example

```
Console(config)#interface ethernet 1/3
Console (config-if)#switchport priority default 5
```

Trunk Settings

On the **Trunk Settings** page, you can specify the default port priority for each port in a switch trunk. All packets entering the switch that are untagged (do not already have a priority value) are tagged with the specified default port priority and then sorted into the appropriate priority queue at the output port.

For each trunk listed in the **Trunk** column, you can assign the default port priority (from 0 to 7) to untagged frames received on any port in the trunk. The default setting is 0.

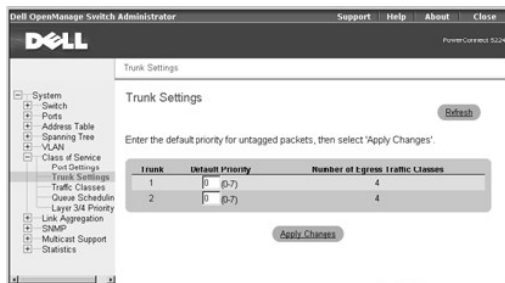

CLI Commands

The following table summarizes the equivalent CLI command for items in the **Class of Service/Trunk Settings** page.

Command	Usage
switchport priority default <i>default-priority-id</i>	Sets a priority for the incoming untagged frames or the priority of frames received by the device connected to the specified interface

Example

```
Console(config)#interface port-channel 2
Console (config-if)#switchport priority default 5
```

Traffic Classes

On the **Traffic Classes** page, you can configure the mapping of frame priority tags to each port's four CoS priority queues.

Each IEEE 802.1p priority level (from 0 to 7) listed in the **Priority** column can be mapped to one of the switch's four traffic class queues (from 0 to 3). The number 0 represents a low priority and higher values represent higher priorities.

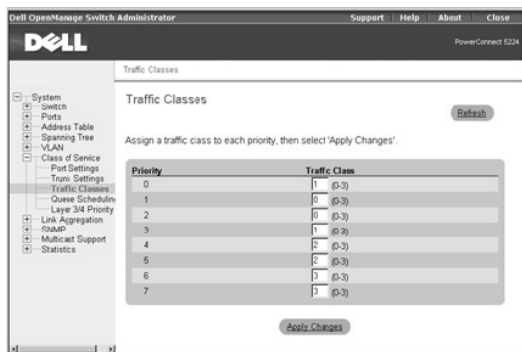

CLI Commands

The following table summarizes the equivalent CLI commands for items in the **Class of Service/Traffic Classes** page.

Command	Usage
<code>queue cos-map <i>queue_id</i> [<i>cos1</i> ... <i>cosn</i>]</code>	Assigns traffic class values to the CoS priority queues. Use the no form command to set the CoS map to the default values.
<code>show queue cos-map [interface]</code>	Shows the CoS priority map.

Example

```

Console(config)#queue cos-map 0 0 1 2

Console(config)#queue cos-map 1 3

Console(config)#queue cos-map 2 4 5

Console(config)#queue cos-map 3 6 7

Console#show queue cos-map

Information of Eth 1/1

Queue ID  Traffic class
-----  -
0         0 1 2
1         3
2         4 5
3         6 7
.
.
.

```

Queue Scheduling

In the **Queue Scheduling** page, you can configure Weighted Round Robin (WRR) queuing for the switch ports.

The following options are available:

- 1 **WRR Setting Table** — Displays a list of weight values for each switch CoS queue
- 1 **Weight Value** — Sets a new weight value for a CoS

To change a table setting, select the entry in the **WRR Setting Table**, type the new weight in the **Weight Value** box, and then click **Apply Changes**. If you don't want to save the changes, click **Refresh**.

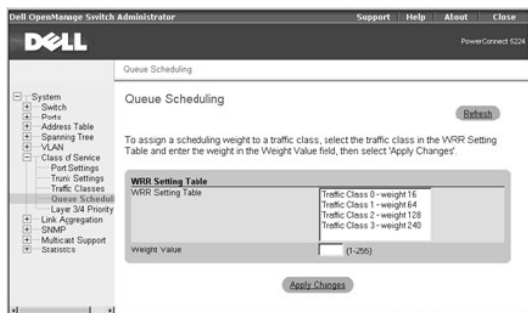

CLI Commands

The following table summarizes the equivalent CLI commands for items in the **Class of Service/Queue Scheduling** page.

Command	Usage
queue bandwidth <i>weight1...weight4</i>	Assigns WRR weights to the four CoS priority queues. Use the no form command to restore the default weights.
show queue bandwidth	Displays the WRR bandwidth allocation for the four CoS priority queues.

Example

```

Console(config)#queue bandwidth 1 4 16 64

Console(config)#exit

Console#show queue bandwidth

Queue ID Weight
-----
0          1
1          4
2         16
3         64

Console#

```

Layer 3/4 Priority

You can assign Layer 3/4 priority to traffic in the switch by considering the settings in the Type of Service (ToS) field in the IP header of a frame. The ToS field can contain an IP Precedence or the more recently released Differentiated Services Code Point (DSCP) value, depending on whether you have DSCP or IP Precedence-aware devices in your network. You can use the **Layer 3/4 Priority** page to identify IP traffic priorities and map the priorities to the CoS values in the priority tag of each frame.

The following figure shows the ToS field structure for IP Precedence and IP DSCP.

IPv4 Packet Header

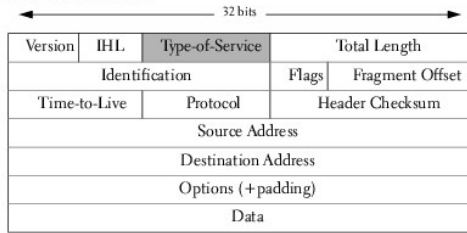

Type-of-Service Octet for IP Precedence

0	1	2	3	4	5	6	7
Precedence				Type-of-Service			<i>zero</i>

Type-of-Service Octet for DSCP

0	1	2	3	4	5	6	7
DSCP						<i>currently unused</i>	

 **NOTE:** The switch allows you to choose between IP Precedence or DSCP priority. Select one of the methods or disable this feature.

IP Precedence

From the **IP Precedence** section, you can map IP Precedence values to traffic class values. These settings apply to all ports on the switch.

The following options are available:

- 1 **IP Precedence Priority Table** — Displays a list of IP Precedence values with mapped CoS values.
- 1 **Class of Service Value** — Maps a CoS value to an IP Precedence value. The number 0 represents low priority and 7 represents high priority.

Click **IP Precedence** in the **IP Precedence/DSCP Priority Status** field to enable this feature.

Each IP Precedence value (from 0 to 7) is mapped to one CoS value (from 0 to 7). The number 0 represents the lowest priority and 7 represents the highest priority.

The following table shows the default priority mapping.

IP Precedence Value	CoS Value
0	0
1	1
2	2
3	3
4	4
5	5
6	6
7	7

To change a table setting, click the entry in the **IP Precedence Priority Table**, type the new CoS value in the **Class of Service Value** box, and then click **Apply Changes**. If you don't want to save the changes, click **Refresh**.

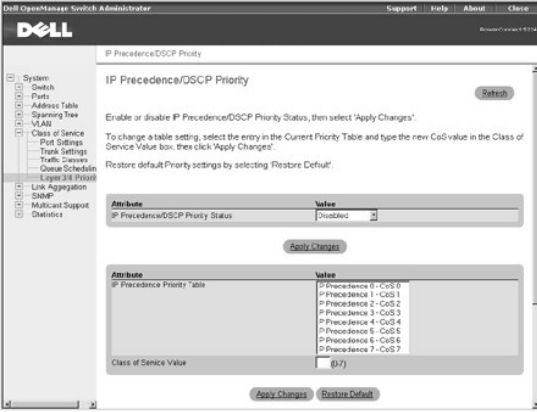

DSCP Priority

In the **IP DSCP Priority** section, you can map DSCP values to traffic class values. These settings apply to all ports on the switch.

The following options are available:

- 1 **DSCP Priority Table** — Displays a list of DSCP values mapped to CoS values.
- 1 **Class of Service Value** — Sets a new CoS for a DSCP value. The number 0 represents low priority and 7 represents high priority.

Click **IP DSCP** in the **IP Precedence/DSCP Priority Status** field to enable this feature.

Each IP DSCP value (from 0 to 63) is mapped to one CoS value (from 0 to 7). The number 0 represents the lowest priority and 7 represents the highest priority.

The following table shows the default priority mapping. All of the DSCP values that are not specified are mapped to CoS value 0.

IP DSCP Value	CoS Value
0	0
8	1
10, 12, 14, 16	2
18, 20, 22, 24	3
26, 28, 30, 32, 34, 36	4
38, 40, 42	5
48	6
46, 56	7

To change a table setting, select the entry in the **DSCP Priority Table**, type the new CoS value in the **Class of Service Value** box, and then click **Apply Changes**. If you don't want to save the changes, click **Refresh**.



CLI Commands

The following table summarizes the equivalent CLI commands for items in the **Class of Service/IP Precedence** web page.

Command	Usage
map ip precedence	Enables IP precedence mapping (IP ToS) for the switch

map ip precedence <i>ip-precedence-value</i> cos <i>cos-value</i>	Sets IP precedence priority (IP ToS priority) for a port or trunk interface (applies to all ports)
show map ip precedence [<i>interface</i>]	Shows the IP precedence priority map
map ip dscp	Enables IP DSCP mapping for the switch
map ip dscp <i>dscp-value</i> cos <i>cos-value</i>	Sets IP DSCP priority for a port or trunk interface (applies to all ports)
show map ip dscp [<i>interface</i>]	Shows the IP DSCP priority map

Example

```

Console(config)#map ip precedence

Console(config)#interface ethernet 1/5

Console(config-if)#map ip precedence 1 cos 1

Console(config-if)#exit

Console(config)#map ip dscp

Console(config)#interface ethernet 1/5

Console(config-if)#map ip dscp 1 cos 0

Console(config-if)#exit

Console(config)#exit

Console#show map ip dscp ethernet 1/1

DSCP mapping status: disabled

Port      DSCP COS
-----  ---  ---
Eth 1/ 1   0   0
Eth 1/ 1   1   0
Eth 1/ 1   2   0
Eth 1/ 1   3   0
.
.
.
Eth 1/ 1  61   0
Eth 1/ 1  62   0
Eth 1/ 1  63   0

Console(config)#

```

Link Aggregation

From the [Link Aggregation](#) page, you can create multiple links between switches that work as one virtual, aggregate link. You can create up to six trunks at a time, with each trunk containing up to four ports. A port trunk offers a dramatic increase in bandwidth for network segments where bottlenecks exist and provides a fault-tolerant link between two devices.

The switch supports two types of link aggregation—static and Link Aggregation Control Protocol (LACP).

LACP-configured ports automatically negotiate a trunked link with LACP-configured ports on another device. You can configure any number of ports on the switch as LACP, as long as they are not already configured as part of another trunk. If ports on another device are also configured as LACP, the switch and the other device negotiate a trunk link between them. If an LACP trunk consists of four ports, all other ports are placed in a standby mode. If one link in the trunk fails, one of the standby ports is automatically activated to replace it.

Use the following guidelines when you configure port trunks:

- 1 Finish configuring port trunks before you connect the corresponding network cables between switches.
- 1 You can configure up to six trunk groups, with up to four ports as a trunk group.
- 1 All ports in the same trunk must consist of the same media type (for example, twisted-pair or fiber).
- 1 The ports on both ends of the trunk must be configured for the same VLAN, speed, duplex mode, flow control, and CoS settings.

- 1 If the target switch has also enabled LACP on the connected ports, the trunk will automatically activate.
- 1 If more than four ports attached to the same target switch have LACP enabled, the additional ports enter standby mode and will only be enabled if one of the active links fails.
- 1 STP, VLAN, and IGMP settings can only be made for the entire trunk through the specified port-channel.

To add a port to a static trunk, click the **Static** toggle button below the port number until the correct trunk number appears. To make a port available for an LACP trunk, click the **LACP** toggle button below the port number until an L appears.

- ➔ **NOTICE:** All ports on both ends of an LACP trunk must be configured for full duplex, either by forced mode or auto-negotiation.
- ➔ **NOTICE:** All ports participating in a trunk should have the same VLAN and CoS settings.
- ➔ **NOTICE:** In order for a port to join an existing trunk through LACP, the port's Flow Control, Speed and Duplex Mode, and Autonegotiation settings must match those of the existing trunk.

To save any changes you make in this page, click **Apply Changes**. If you don't want to save the changes, click **Refresh**.

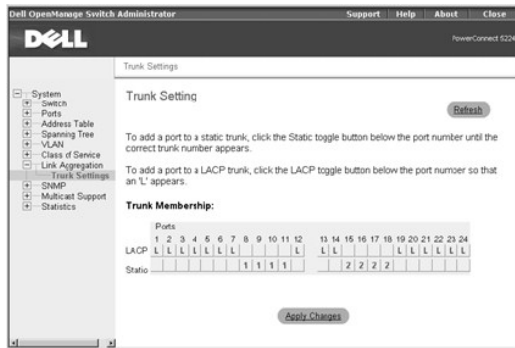

CLI Commands

The following table summarizes the equivalent CLI commands for items in the **Link Aggregation/Trunk Settings** page.

Command	Usage
channel-group <i>channel-id</i>	Adds a port to a trunk. Use the no form command to remove a port from a trunk.
lacp	Enables 802.3ad LACP for the current port or trunk interface.
show interfaces status port-channel <i>channel-id</i>	Displays the status of an enabled trunk interface.

Example

```

Console(config)#interface port-channel 1

Console(config-if)#exit

Console(config)#interface ethernet 1/11

Console(config-if)#channel-group 1

Console(config-if)#exit

Console(config)#interface ethernet 1/8

Console(config-if)#lacp

Console(config-if)#

```

SNMP

The **SNMP** page contains links to the following pages:

- 1 **Communities**
- 1 **Traps**

Communities

On the **Communities** page, you can create different communities and customize access. The **public** string has read-only privileges by default.

The following options are available:

- 1 **SNMP Community Capability** — Indicates that the switch supports up to five community strings.
- 1 **Community List** — Displays a list of the community strings currently configured. Default strings are **public** (read-only access) and **private** (read/write access).
- 1 **Community String** — Allows you to name a new community. Community strings are case sensitive.
- 1 **Access Mode** — Sets the access rights for the new community that you are creating. Access rights are either read-only or read/write.

To add an SNMP community, type the new name in the **Community String** box, select the access rights from the **Access Mode** drop-down menu, and then click **Add Community String**. To delete a community, click the entry in the **Community List**, and then click **Remove Community String**.



CLI Commands

The following table summarizes the equivalent CLI commands for items in the **SNMP/Communities** page.

Command	Usage
snmp-server community <i>string</i> [ro rw]	Defines the community access string for the Simple Network Management Protocol. Read-only access is specified by <i>ro</i> , and read-write access is specified by <i>rw</i> .

Example

```
Console(config)#snmp-server community private rw
Console(config)#
```

Traps

On the **Traps** page, you can specify management stations that receive authentication failure messages and other trap messages from the switch.

NOTICE: The switch does not prevent IP addresses that are not in the **Trap Manager** list from accessing the switch through SNMP. You only need a valid community string for access.

The following options are available:

- 1 **Trap Manager Capability** — Indicates that the switch supports up to five trap managers
- 1 **Trap Manager List** — Displays a list of the trap managers currently configured
- 1 **IP address** — Specifies the IP address of a new management station to receive trap messages
- 1 **Community String** — Identifies the community string for the new trap manager you are creating

To add a trap manager, type the new IP address in the **IP Address** box, type the appropriate SNMP community in the **Community String** box, and then click **Add Trap Manager**. To delete a trap manager, click the entry in the **Trap Manager List**, and then click **Remove Trap Manager**.

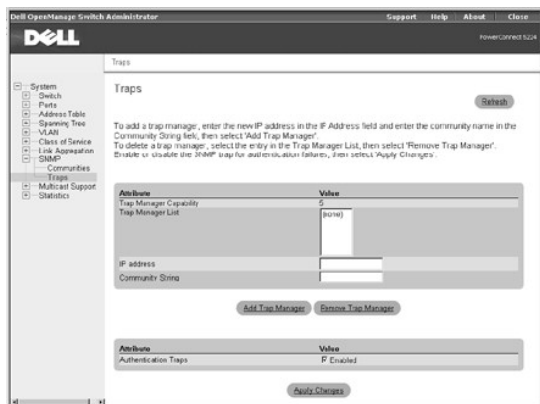

CLI Commands

The following table summarizes the equivalent CLI commands for items in the **SNMP/Traps** page.

Command	Usage
<code>snmp-server host <i>host-addr</i> <i>community-string</i></code>	Specifies the recipient of a SNMP notification operation
<code>snmp-server enable traps [authentication link-up-down]</code>	Enables the device to send SNMP traps

Example

```
Console(config)#snmp-server host 10.1.19.23

Console(config)#snmp-server enable traps link-up-down

Console(config)#
```

Multicast Support

Multicasting is used to support real-time programs such as video conferencing or streaming audio. A multicast server does not have to establish a separate connection with each client. Instead, it broadcasts its service to the network and to any hosts that are supposed to receive the multicast register with their local multicast routers/switches. This approach reduces the network overhead required by a multicast server. However, each time the broadcast traffic passes through a multicast router/switch, the traffic must be carefully queried to ensure that only hosts that subscribe to the service receive the broadcast.

The switch uses the Internet Group Management Protocol (IGMP) to determine if any attached hosts are supposed to receive a specific IP multicast service. IGMP runs between hosts and their adjacent multicast routers/switches. IGMP is a multicast host registration protocol that allows any host to inform its local router that the host is supposed to receive transmissions addressed to a specific multicast group.

IGMP requires one device to act as the *querier* on each LAN subnetwork. The querier is the IGMP-enabled device that periodically sends query messages to all hosts asking them if they want to receive multicast traffic. Hosts respond with *report* messages, indicating to multicast groups that they wish to join or to which group they already belong. The querier then propagates the service requests on to any adjacent multicast switch/router to ensure that it continues to receive the multicast services.

IGMP-enabled devices prune multicast traffic on the network by passively *snooping* on IGMP report messages passing through their ports. The devices monitor host report messages, pick out the multicast group registration information, and then configure filters accordingly so that multicast traffic for particular groups is not forwarded on to ports that do not require it. This capability significantly reduces the multicast traffic on the network.

The **Multicast Support** page contains links to the following pages:

- 1 [IGMP Setting](#)
- 1 [IGMP Member Port Table](#)
- 1 [Multicast Router Port Settings](#)

IGMP Setting

With IGMP Snooping, you can configure the switch to forward multicast traffic intelligently. Based on the IGMP query and report messages, the switch forwards traffic only to the ports that request multicast traffic. This querying prevents the switch from broadcasting the traffic to all ports and possibly disrupting network performance.

 **NOTE:** IGMP requires a router that learns about the presence of multicast groups on its subnets and keeps track of group membership.

On the **IGMP Setting** page, the following options are available:

- 1 **IGMP Status** — Enables IGMP. When IGMP is enabled, the switch monitors network traffic to determine which hosts are supposed to receive multicast traffic.

- 1 **Act as IGMP Querier** — Enables the switch as *Querier*. When Querier is enabled, the switch can serve as the Querier, which is responsible for asking hosts if they are supposed to receive multicast traffic.
- 1 **IGMP Query Count (2–10)** — Sets the maximum number of queries issued for which there has been no response before the switch takes action to solicit reports. (The range is 2 to 10.)
- 1 **IGMP Query Interval (60–125)** — Sets the frequency at which the switch sends IGMP host-query messages. (The range is 60 to 125.)
- 1 **IGMP Report Delay (5–30)** — Sets the time (in seconds) between receiving an IGMP Report for an IP multicast address on a port before the switch sends an IGMP Query out of that port and removes the entry from its list. (The range is 5 to 30.)
- 1 **IGMP Query Timeout (300–500)** — Sets the time the switch waits after the previous querier has stopped querying before it takes over as the querier. (The range is 300 to 500.)
- 1 **IGMP Version** — Sets the protocol version for compatibility with other devices on the network (1 or 2).

To save any changes you make in this page, click **Apply Changes**. If you don't want to save the changes, click **Refresh**.

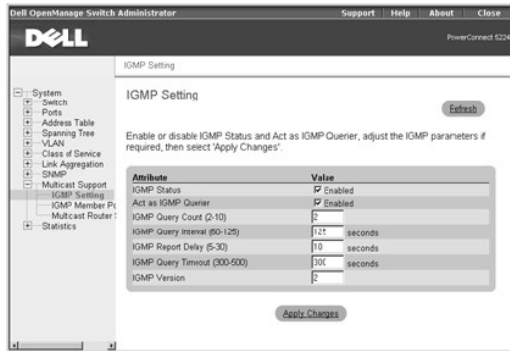

CLI Commands

The following table summarizes the equivalent CLI commands for items in the **Multicast Support/IGMP Setting** page.

Command	Usage
<code>ip igmp snooping</code>	Enables IGMP snooping on the switch
<code>ip igmp snooping querier</code>	Enables the switch as an IGMP snooping querier
<code>ip igmp snooping query-count <i>count</i></code>	Configures the query count
<code>ip igmp snooping query-interval <i>seconds</i></code>	Configures the snooping query interval
<code>ip igmp snooping query-max-response-time <i>seconds</i></code>	Configures the snooping report delay
<code>ip igmp snooping query-time-out <i>seconds</i></code>	Configures the snooping query-timeout
<code>ip igmp snooping version {1 2}</code>	Configures the IGMP snooping version
<code>show ip igmp snooping</code>	Shows the IGMP snooping configuration

Example

```

Console(config)#ip igmp snooping

Console(config)#ip igmp snooping querier

Console(config)#ip igmp snooping query-count 10

Console(config)#ip igmp snooping query-interval 100

Console(config)#ip igmp snooping query-max-response-time 20

Console(config)#ip igmp snooping query-time-out 300

Console(config)#ip igmp snooping version 1

Console(config)#exit

Console#show ip igmp snooping

Service status: Enabled

Querier status: Enabled

Query count: 10

Query interval: 100 sec

Query max response time: 20 sec

```

```

Query time-out: 300 sec

IGMP snooping version: Version 1

Console#

```

IGMP Member Port Table

You can use the **IGMP Member Port Table** page to assign ports that are attached to hosts that are supposed to receive a specific multicast service.

The following options are available:

- 1 **VLAN ID** — Specifies the VLAN ID
- 1 **Multicast IP Address** — Allows you to select or add the IP address for a specific multicast service
- 1 **New IP Address** — Specifies the IP address of a new multicast service
- 1 **Port/Trunk Toggle Buttons** — Allows you to select ports or trunks to receive the specified multicast service by toggling the value of the port/trunk button:
 - o 'S' — Statically sets a port or trunk as a group member of the multicast service
 - o 'D' — Indicates that a port or trunk has been dynamically set as a group member of the multicast service
 - o 'BLANK' — Indicates that the port or trunk is not a group member of the multicast service

NOTICE: You must set at least one port or trunk as a static member before you add a new multicast IP address. If you remove all static members from a group, the IP address is also removed.

To save any changes you make in this page, click **Apply Changes**. If you don't want to save the changes, click **Refresh**.

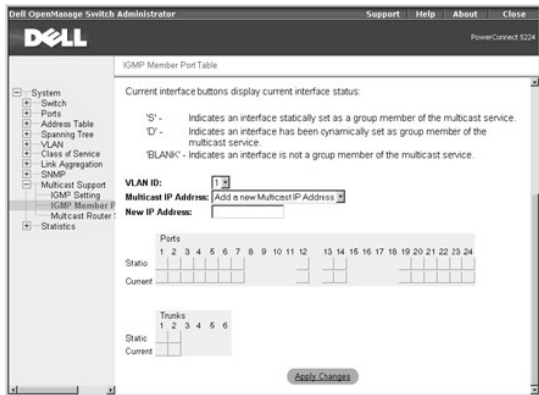

CLI Commands

The following tables summarize the equivalent CLI commands for items in the **Multicast Support/IGMP Member Port Table** page.

Command	Usage
<code>ip igmp snooping vlan <i>vlan-id</i> static <i>ip-address</i> <i>interface</i></code>	Adds a port to a multicast group
<code>show bridge <i>bridge-group</i> multicast [<i>vlan vlan-id</i>] [<i>user</i> <i>igmp-snooping</i>]</code>	Shows the multicast list with MAC and IP addresses

Example

```

Console(config)#ip igmp snooping vlan 1 static 224.1.2.3 ethernet 1/11

Console(config)#exit

Console#show bridge 1 multicast

VLAN M'cast IP addr. Member ports Type
-----
1 224.1.2.3      Eth 1/11      User

Console#

```

Multicast Router Port Settings

You can use the **Multicast Router Port Settings** page to display or set ports on the switch that are attached to a neighboring multicast router/switch for each

VLAN ID.

The following options are available:

- 1 **VLAN ID** — Specifies the VLAN ID
- 1 **Port/Trunk Toggle Buttons** — Allows you to select ports or trunks that are attached to a neighboring multicast router/switch by toggling the value of the port/trunk button:
 - o **'S'** — Statically attaches a port or trunk to a multicast router/switch
 - o **'D'** — Indicates that a port or trunk has been dynamically attached to a multicast router/switch
 - o **'BLANK'** — Indicates that the port or trunk is not attached to a multicast router/switch

To save any changes you make in this page, click **Apply Changes**. If you don't want to save the changes, click **Refresh**.

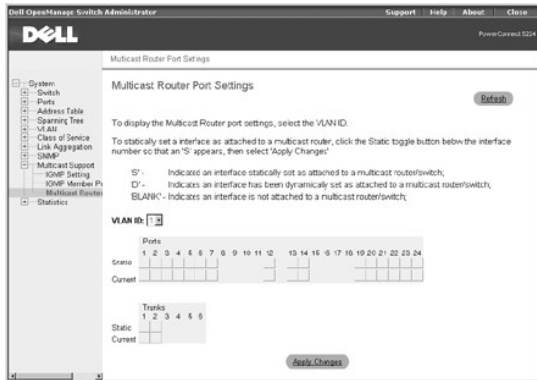

CLI Commands

The following table summarizes the equivalent CLI commands for items in the **Multicast Support/Multicast Router Port Settings** page.

Command	Usage
<code>ip igmp snooping vlan <i>vlan-id</i> mrouter <i>interface</i></code>	Statically configures a multicast router port
<code>show ip igmp snooping mrouter [vlan <i>vlan-id</i>]</code>	Displays information on statically configured and dynamically learned multicast router ports

Example

```
Console(config)#ip igmp snooping vlan 1 mrouter ethernet 1/5

Console(config)#exit

Console#show ip igmp snooping mrouter vlan 1

VLAN M'cast Router Port Type
-----
1 Eth 1/ 5          Static

Console#
```

Statistics

From the **Statistics** page, you can chart a variety of system data. You can see the value of each bar or line in the chart by clicking the bar. For each chart, after you have set all the variables, click **Draw**.

 **NOTE:** Rates are displayed as counts per second. Counters are cumulative from the last time the system was booted.

The **Statistics** page contains links to the following pages:

- 1 **Chart**
- 1 **Table**

Chart

The **Chart** page compares one type of statistic across all ports or trunks. You must define the following variables:

- 1 **Statistics** — Specifies the type of system data to monitor
- 1 **Refresh Rate** — Specifies the time interval between automatic refreshes

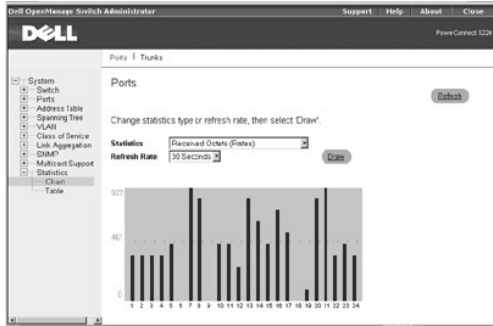

Table

The **Table** page lists, in table format, all statistics counters for a specific port or trunk. You must specify the port or trunk from the drop-down menus, and then click **Query**.

Interface Statistics	Counter	Rate
Received Octets	451288	3742
Received Unicast Packets	2666	36
Received Multicast Packets	0	0
Received Discarded Packets	0	0
Received Discarded Packets	0	0
Received Unknown Packets	0	0
Received Errors	0	0
Transmit Octets	343893	30749
Transmit Unicast Packets	3380	47
Transmit Multicast Packets	0	0
Transmit Discarded Packets	0	0
Transmit Discarded Packets	0	0
Transmit Errors	0	0

CLI Commands

The following table summarizes the equivalent CLI commands for items in the **Statistics/Table** page.

Command	Usage
show interfaces counters <i>interface</i>	Statically configures a multicast router port
clear counters <i>interface</i>	Clears statistics on an interface

NOTE: Clearing counters are only available in the CLI.

Example

```

Console#show interfaces counters ethernet 1/17

Ethernet 1/17

If table stats:

  Octets input: 91248, Octets output: 343887

  Unitcast input: 680, Unitcast output: 593

  Discard input: 0, Discard output: 0

  Error input: 0, Error output: 0

  Unknown protos input: 0, QLen output: 0

Extended iftable stats:

```

```
Multi-cast input: 0, Multi-cast output: 1854
Broadcast input: 138, Broadcast output: 165
Ether-like stats:
Alignment errors: 0, FCS errors: 0
Single Collision frames: 0, Multiple collision frames: 0
SQE Test errors: 0, Deferred transmissions: 0
Late collisions: 0, Excessive collisions: 0
Internal mac transmit errors: 0, Internal mac receive errors: 0
Frame too longs: 0, Carrier sense errors: 0
RMON stats:
Drop events: 0, Octets: 435135, Packets: 3430
Broadcast pkts: 303, Multi-cast pkts: 1854
Undersize pkts: 0, Oversize pkts: 0
Fragments: 0, Jabbers: 0
CRC align errors: 0, Collisions: 997976404
Packet size <= 64 octets: 2584, Packet size 65 to 127 octets: 211
Packet size 128 to 255 octets: 198, Packet size 256 to 511 octets: 317
Packet size 512 to 1023 octets: 95, Packet size 1024 to 1518 octets: 25
Console#
Console#configure
Console(config)#clear counters ethernet 1/17
```

[Back to Contents Page](#)

[Back to Contents Page](#)

VLANs

Dell™ PowerConnect™ 5224 Systems User's Guide

- [VLANs and Frame Tagging](#)
 - [VLAN Configuration](#)
 - [Automatic VLAN Registration](#)
 - [VLAN Examples](#)
-

VLANs and Frame Tagging

The PowerConnect 5224 switch supports IEEE 802.1Q-compliant virtual LANs (VLANs). This capability provides a highly efficient architecture for establishing VLANs within a network and for controlling broadcast/ multicast traffic between workgroups. Central to this capability is an explicit frame tagging approach for carrying VLAN information between interconnected network devices.

With frame tagging, a four-byte data tag field is attached to frames that cross the network. The tag identifies to which VLAN the frame belongs. The tag may be added to the frame by the end station itself or by a network device, such as a switch. In addition to VLAN information, the relative priority of the frame in the network can be specified by the tag.

VLANs provide greater network efficiency by reducing broadcast traffic, and they also allow you to make network changes without having to update IP addresses or IP subnets. VLANs inherently provide a high level of network security, since traffic must pass through a Layer 3 switch or a router to reach a different VLAN.

The PowerConnect 5224 switch supports the following VLAN features:

- 1 Up to 255 VLANs based on the IEEE 802.1Q standard
 - 1 Distributed VLAN learning across multiple switches using explicit or implicit tagging and GVRP (GARP VLAN Registration Protocol)
 - 1 Port overlapping, allowing a port to participate in multiple VLANs
 - 1 End stations that can belong to multiple VLANs
 - 1 Passing traffic between VLAN-aware and VLAN-unaware devices
 - 1 Four-level priority tagging
 - 1 Link aggregation with VLANs
-

VLAN Configuration

By default, VLAN operation on the switch is enabled. Therefore, all frames are transferred internally through the switch with a VLAN tag. This tag may already be on the frame entering the switch, or added to the frame by the switch. VLAN information already existing on frames entering the switch is automatically handled by the switch. The switch learns VLAN information from tagged frames and appropriately switches frames out the proper ports based on this information. The configuration of VLANs for frames entering the switch without tags must be made by the user of the switch. This configuration can be made either through the web or console interface, or through Simple Network Management Protocol (SNMP).

Assigning Ports to VLANs

Before enabling VLANs for the switch, you must first assign each port to the VLAN groups in which it will participate. By default, all ports are assigned to VLAN 1 as untagged ports. You should add a tagged port (a port attached to a VLAN-aware device) if you want it to carry traffic for one or more VLANs and the device at the other end of the link also supports VLANs. Assign the port at the other end of the link to the same VLANs. However, if you want a port on this switch to participate in one or more VLANs and the device at the other end of the link does not support VLANs, you must add an untagged port (a port attached to a VLAN-unaware device).

Port-based VLANs are tied to specific ports. The switch's forwarding determination is based on the destination MAC address and its associated port. Therefore, to make valid forwarding and flooding decisions, the switch learns the relationship of the MAC address to its related port (and to the VLAN) at run-time.

VLAN Classification

Packets that the switch receives are treated in the following ways:

- 1 When an untagged packet enters a port, the system automatically tags it with the port's default VLAN ID tag number. Each port has a default VLAN ID setting that is user configurable. The default setting is 1. You can change the default VLAN ID setting for each port from the **VLAN Port Settings** page.
- 1 When a tagged packet enters a port, the default VLAN ID setting has no effect on the tag.
 - o The packet proceeds to the VLAN specified by its VLAN ID tag number.
 - o If the port in which the packet entered does not belong to the VLAN specified by the packet's VLAN ID tag, the system drops the packet.

 **NOTE:** You can change port VLAN membership settings in the **VLAN Membership** page.

- o If the port belongs to the VLAN specified by the packet's VLAN ID, the system can send the packet to other ports with the same VLAN ID.
- 1 Packets leaving the switch are either tagged or untagged depending on that port's membership properties.
- 1 In the **VLAN Membership** page, if a **U** is assigned to a port and VLAN, packets leaving the switch from that port and VLAN are untagged. If a **T** is assigned to a port and VLAN, packets leaving the switch from that port and VLAN are tagged with the respective ID for the VLAN to which that port

belongs.

Port Overlapping

Port overlapping can be used to allow access to commonly shared network resources among different VLAN groups, such as file servers or printers. If you implement VLANs that do not overlap but still need to communicate, you must connect them using a router or Layer 3 switch.

Forwarding Tagged/Untagged Frames

Ports can be assigned to multiple tagged or untagged VLANs. Each port on the switch is, therefore, capable of passing tagged or untagged frames. To forward a frame from a VLAN-aware device to a VLAN-unaware device, the switch first determines where to forward the frame. The switch then strips off the VLAN tag. However, to forward a frame from a VLAN-unaware device to a VLAN-aware device, the switch first determines where to forward the frame. It then inserts a VLAN tag reflecting this port's default VID. The default port VLAN ID is 1, but it can be changed from the **VLAN Port Settings** page.

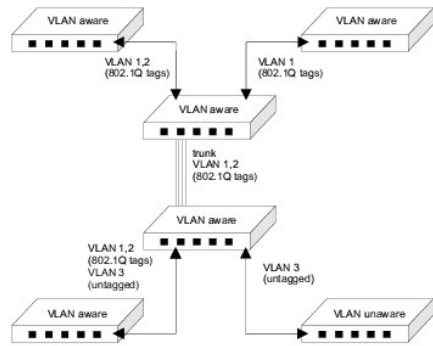

Automatic VLAN Registration

IGMP Snooping (IGMP) defines a way for switches to exchange VLAN information to automatically register VLAN members on ports across the network.

GVRP uses GVRP Bridge Protocol Data Units (GVRP BPDUs) to *advertise* static VLANs to other switches in the network. Any GVRP-enabled device receiving the advertisements can dynamically join the advertised VLAN. All GVRP-dynamically learned VLANs operate as tagged VLANs. A GVRP-enabled port only joins a VLAN when an advertisement for that VLAN is received on that specific port. A GVRP-enabled port forwards advertisements from other ports on the switch but does not join the advertised VLAN.

Hosts, such as computers and servers, can be connected to switch ports that are part of a statically configured VLAN. If GVRP is enabled on the switch, these VLANs are advertised to the rest of the network. If a host (or its network adapter) supports GVRP, it can directly indicate the VLAN groups that it is supposed to join. When the attached GVRP-enabled switch receives the VLAN advertisements, it automatically places the receiving port in the specified VLANs and then forwards the advertisements to all other ports. When the advertisements arrive at another GVRP-enabled switch, the switch places the receiving port in the specified VLANs, and passes the advertisements on to all other ports. As a result, VLAN requirements are spread throughout the network, which allows GVRP-compliant devices to be automatically configured for VLAN groups based solely on host requests.

The following figure shows how GVRP can propagate VLANs across a network.

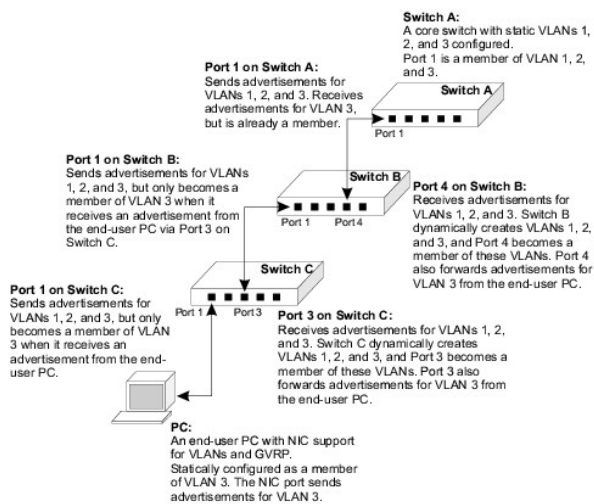

VLAN Examples

The following four examples demonstrate typical web-interface VLAN configurations for the switch.

1. Example 1 demonstrates a simple two-group VLAN setup.
1. Example 2 demonstrates a more elaborate setup, illustrating all possible scenarios for a comprehensive understanding of tagged VLANs.
1. Examples 3 and 4 show how GVRP can be used to automatically propagate VLANs across a network.

Example 1

Example 1 illustrates a simple two-group VLAN setup.

1. In the **VLAN Membership** page, select **Add a new VLAN** from the **Show VLAN** drop-down menu.
2. In the **Name** box, type **New** to represent the new VLAN.
3. In the **VLAN ID** box, type **2** for the new VLAN.
4. Click **Apply Changes** to create the new VLAN.

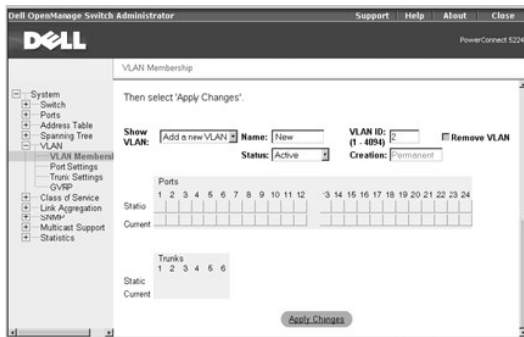

5. Select **VLAN 2** from the **Show VLAN** drop-down menu.

Because there are no ports in the new VLAN, all the port and trunk toggle buttons are blank.

6. Click the toggle buttons in the **Static** row under the port/trunk numbers to select the desired port members of the new VLAN.
7. Click **Apply Changes** to confirm the settings.

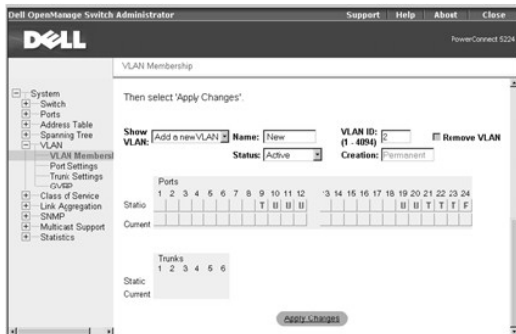

8. To allow untagged packets to participate in the new VLAN, change the Port VLAN IDs for the relevant ports in the **Port Settings** page.
9. Click **Apply Changes** to save any changes. Click **Refresh** if you don't want to save the changes.

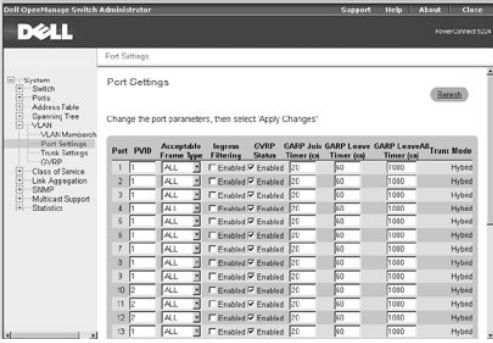

Example 2

Example 2 illustrates a more complicated setup and demonstrates several scenarios for configuring VLANs.

1. Set up four VLANs, as shown in following table.

All switch ports remain as members of the default VLAN (VLAN ID 1).

VLAN ID	Name	Port Members (Tagged/Untagged)
2	Admin	1 (U), 2 (U), 10 (U)
5	Internal	1 (U), 4 (U), 5 (U)
10	Web	1 (T), 9 (T), 10 (T), 11 (U), 12 (U)
15	Collocation	1 (U), 2 (U), 14 (U)

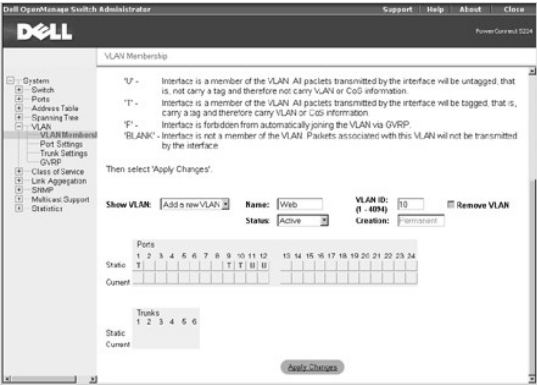

2. Set up the Port VLAN IDs (PVIDs), as shown in the following figure:

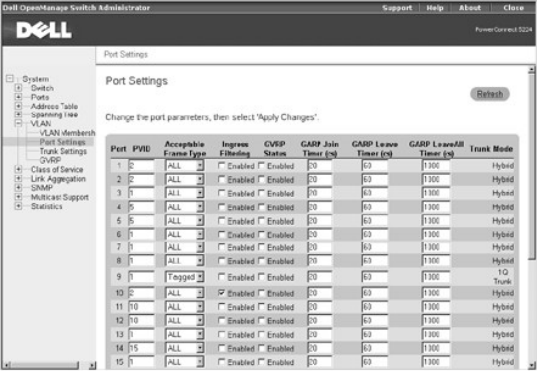

The specific ports shown in the previous figure have the following PVID settings. The PVID settings for each port are configured in the **Port Settings** page.

Port 01: 2	Port 05: 5	Port 09: 1	Port 13: 1
Port 02: 2	Port 06: 1	Port 10: 2	Port 14: 15
Port 03: 1	Port 07: 1	Port 11: 10	Port 15: 1
Port 04: 5	Port 08: 1	Port 12: 10	Port 16: 1

The PVID of a port must be set to a VLAN ID of which the port is an untagged member.

NOTE: Port 9 cannot be removed from VLAN 1 because its PVID is set to VLAN 1.

- Return to the VLAN Membership page and remove the ports configured in this example (1, 2, 4, 5, 10, 11, 12, 14) from VLAN 1.

The VLANs set up in the this example procedure produce the following results:

- If an untagged packet enters Port 4, the switch tags it with a VLAN tag value of 5. The packet can be forwarded to Port 5 and/or 1. As the packet leaves Port 5 and/or 1, it is stripped of its tag and becomes an untagged packet.
- If a tagged packet with a VLAN tag value 5 enters Port 4, the packet has access to Ports 5 and 1. If the packet leaves Port 5 and/or 1, it is stripped of its tag as it leaves the switch and becomes an untagged packet.
- If a tagged packet with a VLAN tag value 10 enters Port 9, it can be forwarded to Ports 1, 10, 11, and 12. If the packet leaves Port 1 or 10, it is tagged with a VLAN ID value of 10. If the packet leaves Port 11 or 12, it leaves as an untagged packet.
- If a tagged packet with a VLAN tag value 15 enters Port 9, it is forwarded to ports in VLAN 15, even though Port 9 is not a member of VLAN 15. The tagged packet enters Port 9 because the **Ingress Filtering** parameter for Port 9 is set to disabled (the default). If Ingress Filtering is disabled, a tagged packet is forwarded if its VLAN tag value matches a VLAN ID already configured on the switch, otherwise it is dropped.
- If a tagged packet with a VLAN tag value of 1 enters Port 10, it is dropped because Port 10 is not a member of VLAN 1 and its **Ingress Filtering** parameter is set to enabled.

Example 3

Example 3 illustrates how GVRP is implemented where VLANs configured in a core aggregation switch are automatically learned by wiring-closet switches.

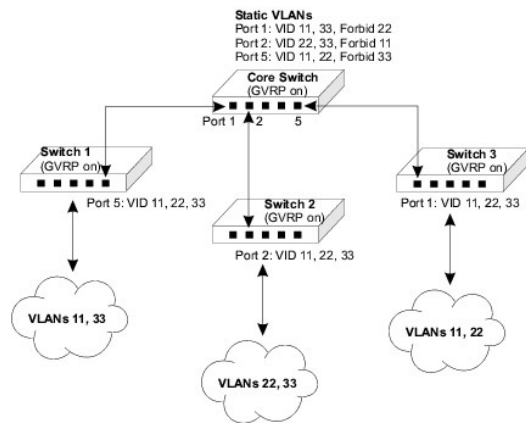

- Set up static VLANs in the core switch, as shown in the following table.

VLAN ID	Name	Port Members (Tagged/Forbidden)
11	Red	1 (T), 3 (T), 2 (F)
22	Green	2 (T), 3 (T), 1 (F)
33	Blue	1 (T), 2 (T), 3 (F)

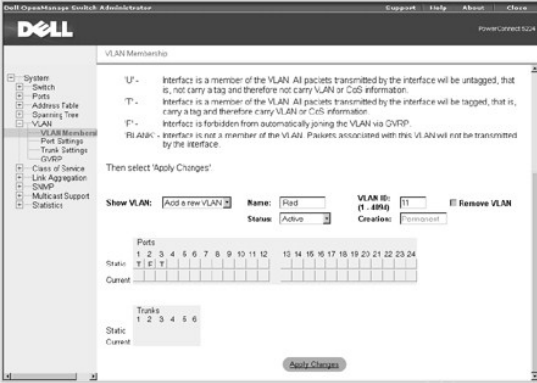

- From the core switch web interface, go to the **VLAN/GVRP** page and ensure that GVRP **Status** is set to **enabled**.
- For the other three switches, ensure that GVRP is enabled globally in the **VLAN/GVRP** page, as well as on ports connecting to the core switch in the **VLAN/Port Settings** page.

With GVRP enabled on the core switch, GVRP advertisements for the three static VLANs are sent from all ports on the switch. When the three wiring-closet switches receive the advertisements, they dynamically create the VLANs and the receiving ports join these VLANs.

The clouds connected to the wiring closet switches in the [previous figure](#) represent other switches and end-users on that network segment. By setting one VLAN as forbidden on the connecting port, the core switch limits each network segment to only two of the VLANs. For example, users attached to Switch 3 have access to VLANs 11 and 22, but not to VLAN 33. End-user requests enable ports on Switch 3 to join VLAN 33, but these users do not have access to the rest of the network.

Example 4

Example 4 illustrates how GVRP is implemented where VLANs configured in wiring-closet switches are automatically recognized by a core aggregation switch.

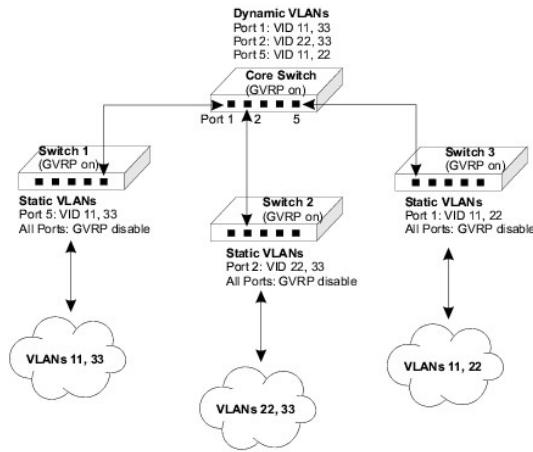

- Set up static VLANs in Switch 1, as shown in the following table:

VLAN ID	Name	Port Members (Tagged/Untagged)
11	Red	5 (T), (other ports as required)
33	Blue	5 (T), (other ports as required)

- Set up static VLANs in Switch 2, as shown in the following table:

VLAN ID	Name	Port Members (Tagged/Untagged)
22	Green	2 (T), (other ports as required)
33	Blue	2 (T), (other ports as required)

- Set up static VLANs in Switch 3, as shown in the following table:

VLAN ID	Name	Port Members (Tagged/Untagged)
11	Red	1 (T), (other ports as required)
22	Green	1 (T), (other ports as required)

4. For each of the three wiring-closet switches, ensure that GVRP is enabled globally in the **VLAN/GVRP** page.
5. For each of the three wiring-closet switches, ensure that GVRP is disabled for each port in the **VLAN/Port Settings** page.
6. For the core switch, ensure that GVRP is enabled globally in the **VLAN/GVRP** page, as well as on ports connecting to the wiring-closet switches in the **VLAN/Port Settings** page.

With GVRP enabled on the wiring closet switches, GVRP advertisements for the configured static VLANs are sent to the core switch. When the core switch receives the advertisements, it dynamically creates the VLANs and places the receiving ports in these VLANs.

The GVRP port settings on the wiring-closet switches need to be set to **disabled**. This setting prevents these switches from dynamically creating other VLANs, or adding port members to the existing static VLANs. The global GVRP switch setting still enables the static VLANs to be advertised to the rest of the network. For example, users attached to Switch 3 have access to VLANs 11 and 22, but not to VLAN 33. VLAN 33 cannot be created on Switch 3, even though advertisements are received on Port 1 from other switches in the network.

[Back to Contents Page](#)

Appendix

Dell™ PowerConnect™ 5224 Systems User's Guide

- [Troubleshooting](#)
 - [Downloading Firmware Through the Console Port](#)
 - [Technical Specifications](#)
 - [Getting Help](#)
 - [Regulatory Notices](#)
-

Troubleshooting

This section explains how to isolate and diagnose problems with the switch. If you have a problem that is not listed here and you cannot solve it, contact Dell (see "[Getting Help](#)").

LEDs

- 1 All light-emitting diode (LEDs) are off.

Ensure that:

- You are using an RJ-45 (network) cable and not an RJ-11 (telephone) cable to connect to the switch.
- The power cable is firmly connected to the relevant switch unit and to the supply outlet. If the connection is secure and there is still no power, you may have a faulty power cable.
- The switch has sufficient space for adequate airflow on both sides.

🔴 **NOTICE:** Operating temperature for the switch must not exceed 40°C (104°F). Do not place the switch in the direct sunlight or near warm air exhausts or heaters.

- 1 When the switch powers on, the **Diag** LED lights are red.
 - The relevant switch unit failed its power on self-test because of an internal problem. See "[Getting Help](#)" for more information.

Ports

- 1 The port does not function.

Ensure that:

- The cable connections are secure and the cables are connected to the correct ports at both ends of the link.
- The port status is set to **Enable** and the autonegotiation feature is enabled at the switch. See "[Port Configuration](#)" for more information.

Management Access

- 1 The terminal cannot access the switch.

Ensure that:

- Your terminal is correctly configured to operate as a VT100 terminal.
- You are using a proper null-modem cable.
- You have set the terminal emulator program to VT100-compatible, 8 data bits, 1 stop bit, no parity and 9600 bps. See "[Connecting the Console Port](#)" for more information.

- 1 You cannot access the switch using Telnet.

Ensure that:

- You have configured the switch's management virtual local area network (VLAN) with a valid Internet Protocol (IP) address, subnet mask, and default gateway.
- Your management station has management VLAN access (see "[Management VLAN Access](#)").
- The switch is powered up.
- You have a valid network connection to the switch and the port you are using has not been disabled.
- You have not exceeded the maximum number of concurrent Telnet sessions permitted. Try connecting again at a later time.

- 1 The web browser cannot access the switch.

Ensure that:

- You have configured the switch's management VLAN with a valid IP address, subnet mask, and default gateway.
- Your management station has management VLAN access (see "[Management VLAN Access](#)").

- o The switch is powered up.
 - o You have a valid network connection to the switch and the port you are using has not been disabled.
- 1 Simple Network Management Protocol (SNMP) management software cannot access the switch.

Ensure that:

- o You have configured the switch's management VLAN with a valid IP address, subnet mask, and default gateway.
- o Your management station has management VLAN access (see "[Management VLAN Access](#)").
- o SNMP is enabled on the switch and community strings have been set with the appropriate access rights.
- o The switch is powered up.
- o You have a valid network connection to the switch and the port you are using has not been disabled.

Management VLAN Access

The following sections describe troubleshooting related to management VLAN access to the switch.

Layer 2 Switch Connections

If you are having problems setting up management access in a network where there are only Layer 2 switch connections to the management station, use the following example to troubleshoot the problem.

Example 1

Three switches, which form three VLANs, are interconnected to a fourth core switch. Network administrators who are connected to one switch need to be able to access all switches. The VLAN port memberships should be set up as shown in the following figure.

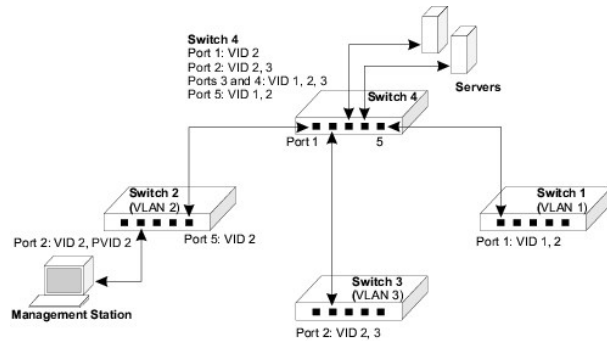

In the preceding figure, the management VLAN is VID 2 and all inter-switch ports are configured as tagged ports. The ports that interconnect the switches must be configured as members of the management VLAN, and the management station must be connected to a port that is also a member of the same VLAN.

For management VLAN access, ensure that:

- 1 You have configured the switch's management VLAN with a valid IP address and subnet mask.
- 1 The management station has an IP address in the same subnet as the management VLAN.
- 1 The management station is connected to a switch port that is a member of the management VLAN, and the port VLAN ID (PVID) is also configured as the management VLAN.
- 1 Ports that interconnect switches in the network are tagged and are members of the management VLAN.

Layer 3 Switch Connections

If you are having problems setting up management access in a network where there are Layer 3 switch connections to the management station, use the following example to troubleshoot the problem.

Example 2

Three Layer 2 switches, which form three VLANs, are interconnected to a fourth Layer 3 switch. Network administrators who are connected to one Layer 2 switch need to be able to access all switches for management. The VLAN port memberships should be set up as shown in the following figure.

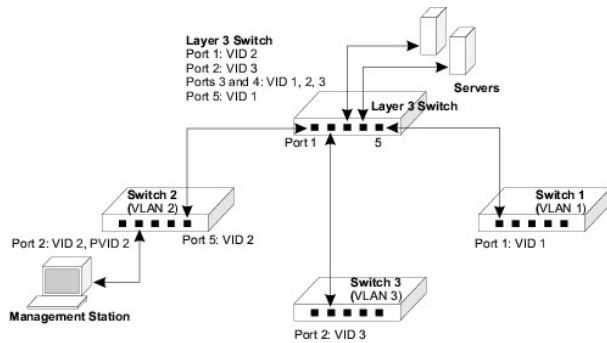

In the preceding figure, the management VLAN is different on each switch, with the Layer 3 switch interconnecting the VLANs. The ports that interconnect the switches are configured as tagged ports. The ports on the Layer 3 switch that connect to the other switches must be configured as members of the management VLAN for each switch.

For management VLAN access, ensure that:

- 1 You have configured the switch's management VLAN with a valid IP address, subnet mask, and default gateway.
- 1 The management station has a valid IP address, subnet mask and default gateway.
- 1 The management station is connected to a switch port that is a member of the management VLAN, and the PVID is also configured as the management VLAN.
- 1 Ports that interconnect switches, including the Layer 3 switch in the network, are tagged and are members of the management VLAN.

Downloading Firmware Through the Console Port

The switch contains two firmware components that can be upgraded: the diagnostics (or Boot-ROM) code and the runtime operation code. You can upgrade the runtime code through the switch's RS-232 serial console port, through a network connection to a Trivial File Transfer Protocol (TFTP) server, or with SNMP management software. You can upgrade the diagnostics code only through the switch's RS-232 serial console port.

NOTICE: Use the switch's web interface to download the runtime code through TFTP (see "[Firmware Upgrade](#)"). Downloading large runtime code files through TFTP is normally much faster than downloading files through the switch's serial port.

You can upgrade switch firmware by connecting a computer directly to the serial console port on the switch's front panel and using VT100 terminal emulation software that supports the XModem protocol. (See "[Connecting the Console Port](#).")

To download firmware:

1. Connect a computer to the switch's console port using a null-modem or crossover RS-232 cable with a female DB-9 connector.
2. Configure the terminal emulation software's communication parameters to 9600 baud, 8 data bits, 1 stop bit, and no parity. Set flow control to **none**.
3. Power cycle the switch.
4. To enter firmware-download mode, press <Ctrl><f> immediately after the diagnostic test results appear in the switch initialization screen.

Screen text similar to that shown in the following example displays:

```

File Name      S/Up Type Size   Create Time
-----
$logfile_1     0   3   64    00:00:07
$logfile_2     0   3   64    00:00:12
diag_0070     0   1  96500  00:06:37
diag_0074     1   1  97780  00:00:05
run_03024     0   2 1121956 00:21:41
run_10020     1   2 1124416 00:00:10
-----

[X]modem Download [D]elete File [S]et Startup File

[R]eturn to Factory Default [C]hange Baudrate [Q]uit

Select>

```

5. Press <c> to change the baud rate of the switch's serial connection.

- Press to select the option for 115200 baud.

There are two baud rate settings available: 9600 and 115200. Using the higher baud rate minimizes the time required to download firmware code files.

- Set your computer's terminal emulation software to match the 115200 baud rate. Press <Enter> to reset communications with the switch.

Select>

```
Change baudrate [A]9600 [B]115200
```

```
Baudrate set to 115200
```

- Before you download the firmware, ensure that the switch has sufficient flash memory space for the new code file.

You can store up to two runtime and two diagnostic code files in the switch's flash memory. Use the **[D]elete File** command to remove a runtime or diagnostic file that is not set as the startup file (the **S/Up** setting for the file is 0).

- Press <x> to download the new code file.

If you are using Windows HyperTerminal, click **Transfer** and then click **Send File**. Select the XModem Protocol and use the **Browse** button to find the required firmware code file on your computer.

The **Xmodem file send** window displays the progress of the download procedure.

NOTICE: The download file must be a PowerConnect 5224 binary software file from Dell.

- After the file has been downloaded, press <r> for runtime code or <d> for diagnostic code when **Update Image File:** appears.
- Specify a name for the downloaded code file. Filenames can be up to 32 characters, are case sensitive, and cannot contain spaces.

The following figure shows an example of the download procedure for a runtime code file:

```
Select>x
```

```
Xmodem Receiving Start ::
```

```
[R]untime
```

```
[D]iagnostic
```

```
Update Image File:r
```

```
Runtime Image Filename : run_10030
```

```
Updating file system.
```

```
File system updated.
```

```
[Press any key to continue]
```

- To set the new downloaded file as the startup file, click the **[S]et Startup File** menu option.
- When you have finished downloading code files, click the **[C]hange Baudrate** menu option to change the baud rate of the switch's serial connection back to 9600 baud.
- Set your computer's terminal emulation software baud rate back to 9600 baud. Press <Enter> to reset communications with the switch.
- Press <q> to quit the firmware-download mode and boot the switch.

Technical Specifications

Standards	
Ethernet types supported	IEEE 802.3 Type 10Base-T, IEEE 802.3u Type 100Base-TX, IEEE 802.3z, IEEE 803.ab
Other standards supported	IEEE 802.3x, IEEE 802.1D, IEEE 802.1Q, IEEE 802.1p, IEEE 802.3ac, IEEE 802.3ad
Interfaces	
10/100/1000BASE-T ports	24
SFP transceiver slots	4
RS-232 connector	1
Indicators	
System LEDs	3
Port LEDs:	
10/100/1000BASE-T ports	2 per port
SFP transceiver slots	1 per slot
Power	

Input	100-240 VAC 50-60 Hz
Physical	
Dimensions	440 x 324 x 43 mm (17.3 x 12.8 x 1.7 inches)
Weight	4.36 kg (9.6 lb)
Environmental	
Temperature:	
Operating	0° to 50°C (32° to 122°F)
Storage	-40° to 70°C (-40° to 158°F)
Relative humidity:	
Operating	10% to 90%
Storage	5% to 90%

Getting Help

Technical Assistance

If you need help with a technical problem, Dell is ready to assist you.

1. Make a copy of the Diagnostics Checklist and fill it out.
2. Use Dell's extensive suite of online services available at Dell Support (support.dell.com) for help with installation and troubleshooting procedures.
3. If the preceding steps have not resolved the problem, contact Dell.

NOTE: Call technical support from a telephone near or at the computer so that technical support can assist you with any necessary procedures.

NOTE: Dell's Express Service Code system may not be available in all countries.

When prompted by Dell's automated telephone system, enter your Express Service Code to route the call directly to the proper support personnel. If you do not have an Express Service Code, open the **Dell Accessories** folder, double-click the **Express Service Code** icon, and follow the directions.

For instructions on using the technical support service, see "[Technical Support Service](#)."

NOTE: Some of the following services are not always available in all locations outside the continental U.S. Call your local Dell representative for information on availability.

Online Services

You can access Dell Support at support.dell.com. Select your region on the **WELCOME TO DELL SUPPORT** page, and fill in the requested details to access help tools and information.

You can contact Dell electronically using the following addresses:

- 1 World Wide Web

www.dell.com/

www.dell.com/ap/ (for Asian/Pacific countries only)

www.euro.dell.com (for Europe only)

www.dell.com/la/ (for Latin American countries)

- 1 Anonymous file transfer protocol (FTP)

[ftp.dell.com/](ftp://ftp.dell.com/)

Log in as user: `anonymous`, and use your e-mail address as your password.

- 1 Electronic Support Service

mobile_support@us.dell.com

support@us.dell.com

apsupport@dell.com (for Asian/Pacific countries only)

support.euro.dell.com (for Europe only)

- 1 Electronic Quote Service

sales@dell.com

apmarketing@dell.com (for Asian/Pacific countries only)

- 1 Electronic Information Service

info@dell.com

AutoTech Service

Dell's automated technical support service—AutoTech—provides recorded answers to the questions most frequently asked by Dell customers about their portable and desktop computers.

When you call AutoTech, use your touch-tone telephone to select the subjects that correspond to your questions.

The AutoTech service is available 24 hours a day, 7 days a week. You can also access this service through the technical support service. For the telephone number to call, see the [contact numbers](#) for your region.

Automated Order-Status Service

To check on the status of any Dell products that you have ordered, you can go to support.dell.com, or you can call the automated order-status service. A recording prompts you for the information needed to locate and report on your order. For the telephone number to call, see the [contact numbers](#) for your region.

Technical Support Service

Dell's technical support service is available 24 hours a day, 7 days a week, to answer your questions about Dell hardware. Our technical support staff uses computer-based diagnostics to provide fast, accurate answers.

To contact Dell's technical support service, see "[Before You Call](#)" and then call the number for your country as listed in "[Contacting Dell](#)."

Problems With Your Order

If you have a problem with your order, such as missing parts, wrong parts, or incorrect billing, contact Dell for customer assistance. Have your invoice or packing slip handy when you call. For the telephone number to call, see the [contact numbers](#) for your region.

Product Information

If you need information about additional products available from Dell, or if you would like to place an order, visit the Dell website at www.dell.com. For the telephone number to call to speak to a sales specialist, see the [contact numbers](#) for your region.

Returning Items for Warranty Repair or Credit

Prepare all items being returned, whether for repair or credit, as follows:

1. Call Dell to obtain a Return Material Authorization Number, and write it clearly and prominently on the outside of the box.
For the telephone number to call, see the [contact numbers](#) for your region.
2. Include a copy of the invoice and a letter describing the reason for the return.
3. Include a copy of the Diagnostics Checklist indicating the tests you have run and any error messages reported by the Dell Diagnostics.
4. Include any accessories that belong with the item(s) being returned (power cables, software floppy disks, guides, and so on) if the return is for credit.
5. Pack the equipment to be returned in the original (or equivalent) packing materials.

You are responsible for paying shipping expenses. You are also responsible for insuring any product returned, and you assume the risk of loss during shipment to Dell. Collect On Delivery (C.O.D.) packages are not accepted.

Returns that are missing any of the preceding requirements will be refused at Dell's receiving dock and returned to you.

Before You Call

NOTE: Have your Express Service Code ready when you call. The code helps Dell's automated-support telephone system direct your call more efficiently.

Remember to fill out the Diagnostics Checklist. If possible, turn on your computer before you call Dell for technical assistance and call from a telephone at or near the computer. You may be asked to type some commands at the keyboard, relay detailed information during operations, or try other troubleshooting steps possible only at the computer itself. Ensure that the computer documentation is available.

Diagnostics Checklist
Name:
Date:
Address:
Phone number:
Service tag (bar code on the back of the switch):
Express Service Code:
Return Material Authorization Number (if provided by Dell support technician):
Switch Name and Firmware Version:
Error message, beep code, or diagnostic code:
Description of problem and troubleshooting procedures you performed:

Contacting Dell

To contact Dell electronically, you can access the following websites:

- 1 www.dell.com
- 1 support.dell.com (technical support)
- 1 premiersupport.dell.com (technical support for educational, government, healthcare, and medium/large business customers, including Premier, Platinum, and Gold customers)

For specific web addresses for your country, find the appropriate country section in the table below.

NOTE: Toll-free numbers are for use within the country for which they are listed.

When you need to contact Dell, use the electronic addresses, telephone numbers, and codes provided in the following table. If you need assistance in determining which codes to use, contact a local or an international operator.

Country (City) International Access Code Country Code City Code	Department Name or Service Area, Website and E-Mail Address	Area Codes, Local Numbers, and Toll-Free Numbers
Anguilla	General Support	toll-free: 800-335-0031
Antigua and Barbuda	General Support	1-800-805-5924
Argentina (Buenos Aires) International Access Code: 00 Country Code: 54 City Code: 11	Website: www.dell.com.ar	
	Tech Support and Customer Care	toll-free: 0-800-444-0733
	Sales	0-810-444-3355
	Tech Support Fax	11 4515 7139
	Customer Care Fax	11 4515 7138
Aruba	General Support	toll-free: 800-1578
Australia (Sydney) International Access Code: 0011 Country Code: 61 City Code: 2	E-mail (Australia): au_tech_support@dell.com	
	E-mail (New Zealand): nz_tech_support@dell.com	
	Home and Small Business	1-300-65-55-33
	Government and Business	toll-free: 1-800-633-559
	Preferred Accounts Division (PAD)	toll-free: 1-800-060-889
	Customer Care	toll-free: 1-800-819-339
	Corporate Sales	toll-free: 1-800-808-385
	Transaction Sales	toll-free: 1-800-808-312
	Fax	toll-free: 1-800-818-341
Austria (Vienna) International Access Code: 900 Country Code: 43 City Code: 1	Website: support.euro.dell.com	
	E-mail: tech_support_central_europe@dell.com	
	Home/Small Business Sales	01 795 67602
	Home/Small Business Fax	01 795 67605
	Home/Small Business Customer Care	01 795 67603
	Preferred Accounts/Corporate Customer Care	0660 8056
	Home/Small Business Technical Support	01 795 67604
	Preferred Accounts/Corporate Technical Support	0660 8779
	Switchboard	01 491 04 0
Bahamas	General Support	toll-free: 1-866-278-6818
Barbados	General Support	1-800-534-3066
Belgium (Brussels) International Access Code: 00 Country Code: 32 City Code: 2	Website: support.euro.dell.com	
	E-mail: tech_be@dell.com	
	E-mail for French Speaking Customers: support.euro.dell.com/be/fr/emaildell/	
	Technical Support	02 481 92 88
	Customer Care	02 481 91 19
	Home/Small Business Sales	toll-free: 0800 16884
	Corporate Sales	02 481 91 00
	Fax	02 481 92 99
	Switchboard	02 481 91 00
Bermuda	General Support	1-800-342-0671
Bolivia	General Support	toll-free: 800-10-0238
Brazil International Access Code: 00 Country Code: 55 City Code: 51	Website: www.dell.com/br	
	Customer Support, Technical Support	0800 90 3355
	Tech Support Fax	51 481 5470
	Customer Care Fax	51 481 5480
	Sales	0800 90 3390

British Virgin Islands	General Support	toll-free: 1-866-278-6820
Brunei	Customer Technical Support (Penang, Malaysia)	604 633 4966
Country Code: 673	Customer Service (Penang, Malaysia)	604 633 4949
	Transaction Sales (Penang, Malaysia)	604 633 4955
Canada (North York, Ontario)	Automated Order-Status System	toll-free: 1-800-433-9014
International Access Code: 011	AutoTech (automated technical support)	toll-free: 1-800-247-9362
	Customer Care (from outside Toronto)	toll-free: 1-800-387-5759
	Customer Care (from within Toronto)	416 758-2400
	Customer Technical Support	toll-free: 1-800-847-4096
	Sales (direct sales—from outside Toronto)	toll-free: 1-800-387-5752
	Sales (direct sales—from within Toronto)	416 758-2200
	Sales (federal government, education, and medical)	toll-free: 1-800-567-7542
	Sales (major accounts)	toll-free: 1-800-387-5755
	TechFax	toll-free: 1-800-950-1329
Cayman Islands	General Support	1-800-805-7541
Chile (Santiago)	Sales, Customer Support, and Technical Support	toll-free: 1230-020-4823
Country Code: 56		
City Code: 2		
China (Xiamen)	Tech Support website: support.ap.dell.com/china	
Country Code: 86	Tech Support E-mail: cn_support@dell.com	
	Tech Support Fax	818 1350
City Code: 592	Home and Small Business Technical Support	toll-free: 800 858 2437
	Corporate Accounts Technical Support	toll-free: 800 858 2333
	Customer Experience	toll-free: 800 858 2060
	Home and Small Business	toll-free: 800 858 2222
	Preferred Accounts Division	toll-free: 800 858 2062
	Large Corporate Accounts GCP	toll-free: 800 858 2055
	Large Corporate Accounts Key Accounts	toll-free: 800 858 2628
	Large Corporate Accounts North	toll-free: 800 858 2999
	Large Corporate Accounts North Government and Education	toll-free: 800 858 2955
	Large Corporate Accounts East	toll-free: 800 858 2020
	Large Corporate Accounts East Government and Education	toll-free: 800 858 2669
	Large Corporate Accounts Queue Team	toll-free: 800 858 2572
	Large Corporate Accounts South	toll-free: 800 858 2355
	Large Corporate Accounts West	toll-free: 800 858 2811
Large Corporate Accounts Spare Parts	toll-free: 800 858 2621	
Colombia	General Support	980-9-15-3978
Costa Rica	General Support	0800-012-0435
Czech Republic (Prague)	Website: support.euro.dell.com	
International Access Code: 00	E-mail: czech_dell@dell.com	
	Technical Support	02 22 83 27 27
Country Code: 420	Customer Care	02 22 83 27 11
	Fax	02 22 83 27 14
City Code: 2	TechFax	02 22 83 27 28
	Switchboard	02 22 83 27 11
Denmark (Copenhagen)	Website: support.euro.dell.com	
International Access Code: 00	E-mail Support (portable computers): den_nbk_support@dell.com	
	E-mail Support (desktop computers): den_support@dell.com	
Country Code: 45	E-mail Support (servers): Nordic_server_support@dell.com	
	Technical Support	7023 0182
	Customer Care (Relational)	7023 0184
	Home/Small Business Customer Care	3287 5505
	Switchboard (Relational)	3287 1200
	Fax Switchboard (Relational)	3287 1201
	Switchboard (Home/Small Business)	3287 5000
	Fax Switchboard (Home/Small Business)	3287 5001
Dominica	General Support	toll-free: 1-866-278-6821
Dominican Republic	General Support	1-800-148-0530

Ecuador	General Support	toll-free: 999-119
El Salvador	General Support	01-899-753-0777
Finland (Helsinki)	Website: support.euro.dell.com	
International Access Code: 990	E-mail: fin_support@dell.com	
Country Code: 358	E-mail Support (servers): Nordic_support@dell.com	
City Code: 9	Technical Support	09 253 313 60
	Technical Support Fax	09 253 313 81
	Relational Customer Care	09 253 313 38
	Home/Small Business Customer Care	09 693 791 94
	Fax	09 253 313 99
	Switchboard	09 253 313 00
France (Paris) (Montpellier)	Website: support.euro.dell.com	
International Access Code: 00	E-mail: support.euro.dell.com/fr/fr/emaiddell/	
Country Code: 33	Home and Small Business	
City Codes: (1) (4)	Technical Support	0825 387 270
	Customer Care	0825 823 833
	Switchboard	0825 004 700
	Switchboard (calls from outside of France)	04 99 75 40 00
	Sales	0825 004 700
	Fax	0825 004 701
	Fax (calls from outside of France)	04 99 75 40 01
	Corporate	
	Technical Support	0825 004 719
	Customer Care	0825 338 339
	Switchboard	01 55 94 71 00
	Sales	01 55 94 71 00
	Fax	01 55 94 71 01
Germany (Langen)	Website: support.euro.dell.com	
International Access Code: 00	E-mail: tech_support_central_europe@dell.com	
Country Code: 49	Technical Support	06103 766-7200
City Code: 6103	Home/Small Business Customer Care	0180-5-224400
	Global Segment Customer Care	06103 766-9570
	Preferred Accounts Customer Care	06103 766-9420
	Large Accounts Customer Care	06103 766-9560
	Public Accounts Customer Care	06103 766-9555
	Switchboard	06103 766-7000
Grenada	General Support	toll-free: 1-866-540-3355
Guatemala	General Support	1-800-999-0136
Guyana	General Support	toll-free: 1-877-270-4609
Hong Kong	Technical Support (Dimension™ and Inspiron™)	296 93188
International Access Code: 001	Technical Support (OptiPlex™, Latitude™, and Dell Precision™)	296 93191
Country Code: 852	Customer Service (non-technical, post-sales issues)	800 93 8291
	Transaction Sales	toll-free: 800 96 4109
	Large Corporate Accounts HK	toll-free: 800 96 4108
	Large Corporate Accounts GCP HK	toll-free: 800 90 3708
India	Technical Support	1600 33 8045
	Sales	1600 33 8044
Ireland (Cherrywood)	Website: support.euro.dell.com	
International Access Code: 16	E-mail: dell_direct_support@dell.com	
Country Code: 353	Ireland Technical Support	1850 543 543
City Code: 1	U.K. Technical Support (dial within U.K. only)	0870 908 0800
	Home User Customer Care	01 204 4095
	Small Business Customer Care	01 204 4444
	U.K. Customer Care (dial within U.K. only)	0870 906 0010
	Corporate Customer Care	01 204 4003
	Ireland Sales	01 204 4444
	U.K. Sales (dial within U.K. only)	0870 907 4000
	SalesFax	01 204 0144
	Fax	01 204 5960

	Switchboard	01 204 4444
Italy (Milan) International Access Code: 00 Country Code: 39 City Code: 02	Website: support.euro.dell.com	
	E-mail: support.euro.dell.com/it/it/emaildell/	
	Home and Small Business	
	Technical Support	02 577 826 90
	Customer Care	02 696 821 14
	Fax	02 696 821 13
	Switchboard	02 696 821 12
	Corporate	
	Technical Support	02 577 826 90
	Customer Care	02 577 825 55
Fax	02 575 035 30	
Switchboard	02 577 821	
Jamaica	General Support (dial from within Jamaica only)	1-800-682-3639
Japan (Kawasaki) International Access Code: 001 Country Code: 81 City Code: 44	Website: support.jp.dell.com	
	Technical Support (servers)	toll-free: 0120-1984-98
	Technical Support outside of Japan (servers)	81-44-556-4162
	Technical Support (Dimension™ and Inspiron™)	toll-free: 0120-1982-26
	Technical Support outside of Japan (Dimension and Inspiron)	81-44-520-1435
	Technical Support (Dell Precision™, OptiPlex™, and Latitude™)	toll-free: 0120-1984-33
	Technical Support outside of Japan (Dell Precision, OptiPlex, and Latitude)	81-44-556-3894
	24-Hour Automated Order Service	044 556-3801
	Customer Care	044 556-4240
	Business Sales Division (up to 400 employees)	044 556-1465
	Preferred Accounts Division Sales (over 400 employees)	044 556-3433
	Large Corporate Accounts Sales (over 3500 employees)	044 556-3430
	Public Sales (government agencies, educational institutions, and medical institutions)	044 556-1469
	Global Segment Japan	044 556-3469
Individual User	044 556-1760	
Faxbox Service	044 556-3490	
Switchboard	044 556-4300	
Korea (Seoul) International Access Code: 001 Country Code: 82 City Code: 2	Technical Support	toll-free: 080-200-3800
	Sales	toll-free: 080-200-3600
	Customer Service (Seoul, Korea)	toll-free: 080-200-3800
	Customer Service (Penang, Malaysia)	604 633 4949
	Fax	2194-6202
	Switchboard	2194-6000
Latin America	Customer Technical Support (Austin, Texas, U.S.A.)	512 728-4093
	Customer Service (Austin, Texas, U.S.A.)	512 728-3619
	Fax (Technical Support and Customer Service) (Austin, Texas, U.S.A.)	512 728-3883
	Sales (Austin, Texas, U.S.A.)	512 728-4397
	SalesFax (Austin, Texas, U.S.A.)	512 728-4600 or 512 728-3772
Luxembourg International Access Code: 00 Country Code: 352	Website: support.euro.dell.com	
	E-mail: tech_be@dell.com	
	Technical Support (Brussels, Belgium)	02 481 92 88
	Home/Small Business Sales (Brussels, Belgium)	toll-free: 080016884
	Corporate Sales (Brussels, Belgium)	02 481 91 00
	Customer Care (Brussels, Belgium)	02 481 91 19
	Fax (Brussels, Belgium)	02 481 92 99
Switchboard (Brussels, Belgium)	02 481 91 00	
Macao Country Code: 853	Technical Support	toll-free: 0800 582
	Customer Service (Penang, Malaysia)	604 633 4949
	Transaction Sales	toll-free: 0800 581
Malaysia (Penang) International Access Code: 00 Country Code: 60	Technical Support	toll-free: 1 800 888 298
	Customer Service	04 633 4949
	Transaction Sales	toll-free: 1 800 888 202

City Code: 4	Corporate Sales	toll-free: 1 800 888 213
Mexico International Access Code: 00 Country Code: 52	Customer Technical Support	001-877-384-8979 or 001-877-269-3383
	Sales	50-81-8800 or 01-800-888-3355
	Customer Service	001-877-384-8979 or 001-877-269-3383
	Main	50-81-8800 or 01-800-888-3355
Montserrat	General Support	toll-free: 1-866-278-6822
Netherlands Antilles	General Support	001-800-882-1519
Netherlands (Amsterdam) International Access Code: 00 Country Code: 31 City Code: 20	Website: support.euro.dell.com	
	E-mail: support.euro.dell.com/nl/nl/emaildell/	
	Technical Support	020 674 45 00
	Home/Small and Medium Business	020 674 55 00
	Home/Small and Medium Business Fax	020 674 47 75
	Home/Small and Medium Business Customer Care	020 674 42 00
	Corporate	020 674 50 00
	Corporate Fax	020 674 47 79
New Zealand International Access Code: 00 Country Code: 64	Corporate Customer Care	020 674 43 25
	E-mail (New Zealand): nz_tech_support@dell.com	
	E-mail (Australia): au_tech_support@dell.com	
	Home and Small Business	0800 446 255
	Government and Business	0800 444 617
Nicaragua	Sales	0800 441 567
	Fax	0800 441 566
	General Support	001-800-220-1006
	Norway (Lysaker) International Access Code: 00 Country Code: 47	Website: support.euro.dell.com
E-mail Support (portable computers): nor_nbk_support@dell.com		
E-mail Support (desktop computers): nor_support@dell.com		
E-mail Support (servers): nordic_server_support@dell.com		
Technical Support	671 16882	
Relational Customer Care	671 17514	
Home/Small Business Customer Care	23162298	
Switchboard	671 16800	
Fax Switchboard	671 16865	
Panama	General Support	001-800-507-0962
Peru	General Support	0800-50-669
Poland (Warsaw) International Access Code: 011 Country Code: 48 City Code: 22	Website: support.euro.dell.com	
	E-mail: pl_support@dell.com	
	Customer Service Phone	57 95 700
	Customer Care	57 95 999
	Sales	57 95 999
	Customer Service Fax	57 95 806
	Reception Desk Fax	57 95 998
Switchboard	57 95 999	
Portugal International Access Code: 00 Country Code: 35	E-mail: support.euro.dell.com/es/es/emaildell/	
	Technical Support	800 834 077
	Customer Care	800 300 415 or 800 834 075
	Sales	800 300 410 or 800 300 411 or 800 300 412 or 121 422 07 10
	Fax	121 424 01 12

Puerto Rico	General Support	1-800-805-7545
St. Kitts and Nevis	General Support	toll-free: 1-877-441-4731
St. Lucia	General Support	1-800-882-1521
St. Vincent and the Grenadines	General Support	toll-free: 1-877-270-4609
Singapore (Singapore)	Technical Support	toll-free: 800 6011 051
International Access Code: 005	Customer Service (Penang, Malaysia)	604 633 4949
Country Code: 65	Transaction Sales	toll-free: 800 6011 054
	Corporate Sales	toll-free: 800 6011 053
South Africa (Johannesburg)	Website: support.euro.dell.com	
International Access Code:	E-mail: dell_za_support@dell.com	
09/091	Technical Support	011 709 7710
Country Code: 27	Customer Care	011 709 7707
City Code: 11	Sales	011 709 7700
	Fax	011 706 0495
	Switchboard	011 709 7700
Southeast Asian and Pacific Countries	Customer Technical Support, Customer Service, and Sales (Penang, Malaysia)	604 633 4810
Spain (Madrid)	Website: support.euro.dell.com	
International Access Code: 00	E-mail: support.euro.dell.com/es/es/emaiddell/	
Country Code: 34	Home and Small Business	
City Code: 91	Technical Support	902 100 130
	Customer Care	902 118 540
	Sales	902 118 541
	Switchboard	902 118 541
	Fax	902 118 539
	Corporate	
	Technical Support	902 100 130
	Customer Care	902 118 546
	Switchboard	91 722 92 00
	Fax	91 722 95 83
Sweden (Upplands Vasby)	Website: support.euro.dell.com	
International Access Code: 00	E-mail: swe_support@dell.com	
Country Code: 46	E-mail Support for Latitude and Inspiron: Swe-nbk_kats@dell.com	
City Code: 8	E-mail Support for OptiPlex: Swe_kats@dell.com	
	E-mail Support for Servers: Nordic_server_support@dell.com	
	Technical Support	08 590 05 199
	Relational Customer Care	08 590 05 642
	Home/Small Business Customer Care	08 587 70 527
	Employee Purchase Program (EPP) Support	20 140 14 44
	Fax Technical Support	08 590 05 594
	Sales	08 590 05 185
Switzerland (Geneva)	Website: support.euro.dell.com	
International Access Code: 00	E-mail: swisstech@dell.com	
Country Code: 41	E-mail for French-speaking HSB and Corporate Customers: support.euro.dell.com/ch/fr/emaiddell/	
City Code: 22	Technical Support (Home and Small Business)	0844 811 411
	Technical Support (Corporate)	0844 822 844
	Customer Care (Home and Small Business)	0848 802 202
	Customer Care (Corporate)	0848 821 721
	Fax	022 799 01 90
	Switchboard	022 799 01 01
Taiwan	Technical Support (portable and desktop computers)	toll-free: 00801 86 1011
International Access Code: 002	Technical Support (servers)	toll-free: 0080 60 1256
Country Code: 886	Transaction Sales	toll-free: 0080 651 228 or 0800 33 556
	Corporate Sales	toll-free: 0080 651 227 or 0800 33 555
Thailand	Technical Support	toll-free: 0880 060 07

International Access Code: 001	Customer Service (Penang, Malaysia)	604 633 4949
Country Code: 66	Sales	toll-free: 0880 060 09
Trinidad/Tobago	General Support	1-800-805-8035
Turks and Caicos Islands	General Support	toll-free: 1-866-540-3355
U.K. (Bracknell)	Website: support.euro.dell.com	
International Access Code: 00	Customer Care website: dell.co.uk/lca/customerservices	
Country Code: 44	E-mail: dell_direct_support@dell.com	
City Code: 1344	Technical Support (Corporate/Preferred Accounts/PAD [1000+ employees])	0870 908 0500
	Technical Support (direct/PAD and general)	0870 908 0800
	Global Accounts Customer Care	01344 373 185
		or 01344 373 186
	Home and Small Business Customer Care	0870 906 0010
	Corporate Customer Care	0870 908 0500
	Preferred Accounts (500–5000 employees) Customer Care	01344 373 196
	Central Government Customer Care	01344 373 193
	Local Government & Education Customer Care	01344 373 199
	Health Customer Care	01344 373 194
	Home and Small Business Sales	0870 907 4000
	Corporate/Public Sector Sales	01344 860 456
Uruguay	General Support	toll-free: 000-413-598-2521
U.S.A. (Austin, Texas)	Automated Order-Status Service	toll-free: 1-800-433-9014
International Access Code: 011	AutoTech (portable and desktop computers)	toll-free: 1-800-247-9362
Country Code: 1	Consumer (Home and Home Office)	
	Customer Technical Support	toll-free: 1-800-624-9896
	Customer Service	toll-free: 1-800-624-9897
	DellNet™ Service and Support	toll-free: 1-877-Dellnet (1-877-335-5638)
	Software Application Support	toll-free: 1-800-433-9005
	Employee Purchase Program (EPP)	toll-free: 1-800-695-8133
	(Customer Service and Technical Support)	
	Financial Services website: www.dellfinancialservices.com	
	Financial Services (lease/loans)	toll-free: 1-877-577-3355
	Financial Services (Dell Preferred Accounts [DPA])	toll-free: 1-800-283-2210
	Business (businesses with <400 employees; businesses with 400+ employees and their employees)	
	Service and Technical Support	toll-free: 1-800-822-8965
	Public (government, education, and healthcare)	
	Service and Technical Support	toll-free: 1-800-234-1490
	Employee Purchase Program (EPP)	toll-free: 1-800-695-8133
	(Customer Service and Technical Support)	
	Dell Sales	toll-free: 1-800-289-3355 or toll-free: 1-800-879-3355
	Dell Outlet Store (Dell refurbished computers)	toll-free: 1-888-798-7561
	Software and Peripherals Sales	toll-free: 1-800-671-3355
	Spare Parts Sales	toll-free: 1-800-357-3355
	Extended Service and Warranty Sales	toll-free: 1-800-247-4618
	Fax	toll-free: 1-800-727-8320
	Dell Services for the Deaf, Hard-of-Hearing, or Speech-Impaired	toll-free: 1-877-DELLTTY (1-877-335-5889)
U.S. Virgin Islands	General Support	1-877-673-3355
Venezuela	General Support	8001-3605

Regulatory Notices

FCC Compliance Statement

This equipment generates and uses radio frequency energy. If not installed and used properly, in strict accordance with the instructions provided with the

equipment, it might cause interference to radio and TV communication.

The equipment has been tested and found to comply with the limits for a Class A computing device in accordance with the specifications in Subpart B of Part 15 of FCC rules, which are designed to provide reasonable protection against such interference in a residential installation. However, there is no guarantee that interference will not occur in a particular installation.

To determine if this equipment is causing interference, perform the following test: Turn your Ethernet switch on and off while your radio or TV is showing interference. If the interference disappears when you turn the switch off and reappears when you turn it back on, the switch is causing interference.

The following options are recommended to try to correct the interference:

- 1 Reorient the receiving radio or TV antenna where this may be done safely.
- 1 Relocate the radio, TV or other receiver away from the switch.
- 1 Plug the Ethernet switch into a different power outlet so that the switch and the receiver are on different branch circuits.
- 1 If necessary, consult the place of purchase or an experienced radio/television technician for additional suggestions.

 **CAUTION: Do not use a RJ-11 (telephone) cable to connect your network equipment.**

FCC Notices (U.S. Only)

Class A

This equipment has been tested and found to comply with the limits for a Class A digital device pursuant to Part 15 of the FCC Rules. These limits are designed to provide reasonable protection against harmful interference when the equipment is operated in a commercial environment. This equipment generates, uses, and can radiate radio frequency energy and, if not installed and used in accordance with the manufacturer's instruction manual, may cause harmful interference with radio communications. Operation of this equipment in a residential area is likely to cause harmful interference, in which case you will be required to correct the interference at your own expense.

This device complies with Part 15 of the FCC Rules. Operation is subject to the following two conditions:

- 1 This device may not cause harmful interference.
- 1 This device must accept any interference received, including interference that may cause undesired operation.

IC Notice (Canada Only)

Most Dell computer systems (and other Dell digital apparatus) are classified by the Industry Canada (IC) Interference-Causing Equipment Standard #3 (ICES-003) as Class B digital devices. To determine which classification (Class A or B) applies to your computer system (or other Dell digital apparatus), examine all registration labels located on the bottom or the back panel of your computer (or other digital apparatus). A statement in the form of "IC Class A ICES-003" or "IC Class B ICES-003" will be located on one of these labels. Note that Industry Canada regulations provide that changes or modifications not expressly approved by Dell could void your authority to operate this equipment.

This Class B (or Class A, if so indicated on the registration label) digital apparatus meets the requirements of the Canadian Interference-Causing Equipment Regulations.

Cet appareil numérique de la Classe B (ou Classe A, si ainsi indiqué sur l'étiquette d'enregistrement) respecte toutes les exigences du Règlement sur le Matériel Brouilleur du Canada.

CE Notice (European Union)

Marking by the symbol  indicates compliance of this Dell computer to the EMC Directive and the Low Voltage Directive of the European Union. Such marking is indicative that this Dell system meets the following technical standards:

Set 1: For standard Dell ITE with AC power supplies

- 1 EN 55022 — "Information Technology Equipment — Radio Disturbance Characteristics — Limits and Methods of Measurement."
- 1 EN 55024 — "Information Technology Equipment - Immunity Characteristics - Limits and Methods of Measurement."
- 1 EN 61000-3-2 — "Electromagnetic Compatibility (EMC) - Part 3: Limits - Section 2: Limits for Harmonic Current Emissions (Equipment Input Current Up to and Including 16 A Per Phase)."
- 1 EN 61000-3-3 — "Electromagnetic Compatibility (EMC) - Part 3: Limits - Section 3: Limitation of Voltage Fluctuations and Flicker in Low-Voltage Supply Systems for Equipment With Rated Current Up to and Including 16 A."
- 1 EN 60950 — "Safety of Information Technology Equipment."

For -48 volt-direct-current (VDC) powered systems, the following set of standards applies. See the "Declaration of Conformity" to determine whether a particular system meets EN 50082-1 or EN 50082-2 requirements.

Set 2: For -48-VDC powered systems

- 1 EN 55022 — "Information Technology Equipment — Radio Disturbance Characteristics — Limits and Methods of Measurement."
- 1 EN 50082-1 — "Electromagnetic Compatibility - Generic Immunity Standard - Part 1: Residential, Commercial and Light Industry."
- 1 EN 50082-2 — "Electromagnetic Compatibility - Generic Immunity Standard - Part 2: Industrial Environment."
- 1 EN 60950 — "Safety of Information Technology Equipment."

NOTE: EN 55022 emissions requirements provide for two classifications:

- 1 Class A is for typical commercial areas.
- 1 Class B is for typical domestic areas.

RF INTERFERENCE WARNING: This is a Class A product. In a domestic environment this product may cause radio frequency (RF) interference, in which case the user may be required to take adequate measures.

A "Declaration of Conformity" in accordance with the preceding directives and standards has been made and is on file at Dell Computer Corporation Products Europe BV, Limerick, Ireland.

VCCI Notice (Japan Only)

Class A ITE

この装置は、情報処理装置等電波障害自主規制協議会(VCCI)の基準に基づくクラス A 情報技術装置です。この装置を家庭環境で使用すると電波妨害を引き起こすことがあります。この場合には使用者が適切な対策を講ずるよう要求されることがあります。

This is a Class A product based on the standard of the Voluntary Control Council for Interference (VCCI) for information technology equipment. If this equipment is used in a domestic environment, radio disturbance may arise. When such trouble occurs, the user may be required to take corrective actions.

VCCI Class A ITE Regulatory Mark

If the regulatory label includes the following marking, your computer is a Class A product:

VCCI

NOM Information (Mexico Only)

The following information is provided on the device(s) described in this document in compliance with the requirements of the official Mexican standards (NOM):

Exporter:	Dell Computer Corporation One Dell Way Round Rock, TX 78682
Importer:	Dell Computer de México, S.A. de C.V. Paseo de la Reforma 2620 - 11º Piso Col. Lomas Altas 11950 México, D.F.
Ship to:	Dell Computer de México, S.A. de C.V. al Cuidado de Kuehne & Nagel de México S. de R.I. Avenida Soles No. 55 Col. Peñon de los Baños 15520 México, D.F.
Supply voltage:	100-240 VAC
Frequency:	50-60 Hz
Input current rating:	1.5 A

[Back to Contents Page](#)

Caution: Safety Instructions Dell™ PowerConnect™ 5224 Systems User's Guide

Use the following safety guidelines to ensure your own personal safety and to help protect your system from potential damage.

General

- 1 Observe and follow service markings. Do not service any product except as explained in your system documentation. Opening or removing covers that are marked with the triangular symbol with a lightning bolt may expose you to electrical shock. Components inside these compartments should be serviced only by a trained service technician.
- 1 If any of the following conditions occur, unplug the product from the electrical outlet and replace the part or contact your trained service provider:
 - o The power cable, extension cable, or plug is damaged.
 - o An object has fallen into the product.
 - o The product has been exposed to water.
 - o The product has been dropped or damaged.
 - o The product does not operate correctly when you follow the operating instructions.
- 1 Keep your system away from radiators and heat sources. Also, do not block cooling vents.
- 1 Do not spill food or liquids on your system components, and never operate the product in a wet environment. If the system gets wet, see the appropriate section in your troubleshooting guide or contact your trained service provider.
- 1 Do not push any objects into the openings of your system. Doing so can cause fire or electric shock by shorting out interior components.
- 1 Use the product only with approved equipment.
- 1 Allow the product to cool before removing covers or touching internal components.
- 1 Operate the product only from the type of external power source indicated on the electrical ratings label. If you are not sure of the type of power source required, consult your service provider or local power company.
- 1 Use only approved power cable(s). If you have not been provided with a power cable for your system or for any AC-powered option intended for your system, purchase a power cable that is approved for use in your country. The power cable must be rated for the product and for the voltage and current marked on the product's electrical ratings label. The voltage and current rating of the cable should be greater than the ratings marked on the product.
- 1 To help prevent electric shock, plug the system and peripheral power cables into properly grounded electrical outlets. These cables are equipped with three-prong plugs to help ensure proper grounding. Do not use adapter plugs or remove the grounding prong from a cable. If you must use an extension cable, use a 3-wire cable with properly grounded plugs.
- 1 Observe extension cable and power strip ratings. Make sure that the total ampere rating of all products plugged into the extension cable or power strip does not exceed 80 percent of the ampere ratings limit for the extension cable or power strip.
- 1 To help protect your system from sudden, transient increases and decreases in electrical power, use a surge suppressor, line conditioner, or uninterruptible power supply (UPS).
- 1 Position system cables and power cables carefully; route cables so that they cannot be stepped on or tripped over. Be sure that nothing rests on any cables.
- 1 Do not modify power cables or plugs. Consult a licensed electrician or your power company for site modifications. Always follow your local/national wiring rules.
- 1 When connecting or disconnecting power to hot-pluggable power supplies, if offered with your system, observe the following guidelines:
 - o Install the power supply before connecting the power cable to the power supply.
 - o Unplug the power cable before removing the power supply.
 - o If the system has multiple sources of power, disconnect power from the system by unplugging *all* power cables from the power supplies.
- 1 Move products with care: ensure that all casters and/or stabilizers are firmly connected to the system. Avoid sudden stops and uneven surfaces.

Rack Mounting of Systems

Observe the following precautions for rack stability and safety. Also refer to the rack installation documentation accompanying the system and the rack for specific caution statements and procedures.

Systems are considered to be components in a rack. Thus, "component" refers to any system as well as to various peripherals or supporting hardware.

⚠ CAUTION: Installing systems in a rack without the front and side stabilizers installed could cause the rack to tip over, potentially resulting in bodily injury under certain circumstances. Therefore, always install the stabilizers before installing components in the rack.

After installing system/components in a rack, never pull more than one component out of the rack on its slide assemblies at one time. The weight of more than one extended component could cause the rack to tip over and may result in serious injury.

NOTE: Your system is safety-certified as a free-standing unit and as a component for use in a Dell rack cabinet using the customer rack kit. The installation of your system and rack kit in any other rack cabinet has not been approved by any safety agencies. It is your responsibility to have the final combination of system and rack kit in a rack cabinet evaluated for suitability by a certified safety agency. Dell disclaims all liability and warranties in connection with such combinations.

- 1 System rack kits are intended to be installed in a rack by trained service technicians. If you install the kit in any other rack, be sure that the rack meets the specifications of a Dell rack.

⚠ CAUTION: Do not move racks by yourself. Due to the height and weight of the rack, a minimum of two people should accomplish this task.

- 1 Before working on the rack, make sure that the stabilizers are secured to the rack, extended to the floor, and that the full weight of the rack rests on the floor. Install front and side stabilizers on a single rack or front stabilizers for joined multiple racks before working on the rack.
- 1 Always load the rack from the bottom up, and load the heaviest item in the rack first.
- 1 Make sure that the rack is level and stable before extending a component from the rack.
- 1 Use caution when pressing the component rail release latches and sliding a component into or out of a rack; the slide rails can pinch your fingers.
- 1 After a component is inserted into the rack, carefully extend the rail into a locking position, and then slide the component into the rack.
- 1 Do not overload the AC supply branch circuit that provides power to the rack. The total rack load should not exceed 80 percent of the branch circuit rating.
- 1 Ensure that proper airflow is provided to components in the rack.
- 1 Do not step on or stand on any component when servicing other components in a rack.

⚠ CAUTION: A qualified electrician must perform all connections to DC power and to safety grounds. All electrical wiring must comply with applicable local or national codes and practices.

⚠ CAUTION: Never defeat the ground conductor or operate the equipment in the absence of a suitably installed ground conductor. Contact the appropriate electrical inspection authority or an electrician if you are uncertain that suitable grounding is available.

⚠ CAUTION: The system chassis must be positively grounded to the rack cabinet frame. Do not attempt to connect power to the system until grounding cables are connected. Completed power and safety ground wiring must be inspected by a qualified electrical inspector. An energy hazard will exist if the safety ground cable is omitted or disconnected.

Modems, Telecommunications, or Local Area Network Options

- 1 Do not connect or use a modem during a lightning storm. There may be a risk of electrical shock from lightning.
- 1 Never connect or use a modem in a wet environment.
- 1 Do not plug a modem or telephone cable into the network interface controller (NIC) receptacle.
- 1 Disconnect the modem cable before opening a product enclosure, touching or installing internal components, or touching an uninsulated modem cable or jack.

When Working Inside Your System

Protecting Against Electrostatic Discharge

Static electricity can harm delicate components inside your system. To prevent static damage, discharge static electricity from your body before you touch any of the electronic components, such as the microprocessor. You can do so by periodically touching an unpainted metal surface on the chassis.

You can also take the following steps to prevent damage from electrostatic discharge (ESD):

- 1 When unpacking a static-sensitive component from its shipping carton, do not remove the component from the antistatic packing material until you are ready to install the component in your system. Just before unwrapping the antistatic packaging, be sure to discharge static electricity from your body.
- 1 When transporting a sensitive component, first place it in an antistatic container or packaging.
- 1 Handle all sensitive components in a static-safe area. If possible, use antistatic floor pads and workbench pads and an antistatic grounding strap.

NOTE: Your system may also include circuit cards or other components that contain batteries. These batteries must also be disposed of in a battery deposit

site. For information about such batteries, refer to the documentation for the specific card or component.

[Back to Contents Page](#)